



THE CITY OF GOOSE CREEK CENTRAL CREEK DISTRICT DESIGN STANDARDS





ACKNOWLEDGMENTS

City Council

Gregory Habib, Mayor
Debra Green-Fletcher, Mayor Pro Tem
Jerry Tekac
Christopher Harmon
Gayla McSwain
Hannah Cox
Melissa Enos

City of Goose Creek

Natalie Zeigler, City Administrator
Brian Cook, Assistant City Administrator
Alexis Kiser, Special Projects Manager
Kendra Wise, Planning and Zoning Director
Brenda Moneer, Planner II
Joseph Morris, Intern

Consultant

TSW

CONTENTS

1. Introduction.....	4	Roofs.....	22	Trash Receptacles.....	37
Purpose	4	Windows & Doors.....	22	Kiosks	38
Vision	4	Materials & Colors	24	Bicycle Racks	38
Applicability.....	4	Building Elements	26	Fences, Walls & Gates.....	39
2. Site Planning	6	Building Style	28	Drinking Fountains	40
Connectivity.....	6	Mercantile Style Buildings	29	Fountains/Water Features	40
Access Management	7	Representative Application of		Bollards	40
Open Space	7	Guidelines	32	Tree Grates & Guards.....	41
Building Placement	10	4. Lighting.....	34	6. Landscaping	42
Building Access	12	Parking Lot Lighting.....	34	Street Trees	42
Streetscapes	12	Street Lighting (Public)	34	Parking Lot Trees	42
Parking	13	Street Lighting (Private)	34	Sustainable Landscaping.....	42
Paving	14	Building/Structure Lighting.....	34	Materials.....	48
Screening.....	15	Sign Lighting.....	34		
Stormwater Facilities	16	Building-Mounted Lighting.....	35		
3. Building Design	18	Landscape Lighting	35		
Mass, Scale, and Height	18	5. Private Site Furniture.....	36		
Primary Facade Details	21	Benches.....	36		
		Outdoor Dining.....	37		

1. INTRODUCTION

PURPOSE

These design guidelines are intended to encourage and support the orderly redevelopment of the Central Creek District Overlay, as specified in the city's comprehensive plan.

More specifically, these guidelines:

- **Enhance the unique qualities that make Goose Creek special.** The design guidelines promote local design traditions and use them to shape new development.
- **Implement City plan and policies,** especially the comprehensive plan.
- **Assist with implementation and interpretation of the zoning ordinance.** The guidelines help explain some standards within the City's zoning regulations and provide information to assist with interpretation.
- **Guide design review.** The guidelines serve as the basis for decisions by the City.

VISION

The vision for the Central Creek District is to be Goose Creek's downtown, featuring a mix of residential, commercial, and institutional land uses in a lush, walkable, and resilient setting.

The District features an interconnected, transportation network made up of streets, sidewalks, and paths. Streets are laid out to provide multiple route options, reduce traffic congestions, and support the District's mixed-use vision. Sidewalks and path are provided throughout.

Buildings support this vision by fronting sidewalks with active uses, windows, and doors that promote aesthetics, sense-of-place, and walkability. Their architectural designs create a unique sense of place that distinguishes the Central Creek District from the rest of Goose Creek and nearby communities.

Finally, landscaping, open spaces, and appropriate screening are provided throughout.

APPLICABILITY

1.1. Applicability

These design guidelines apply to all properties in Central Creek District Overlay. The boundaries of the Central Creek District Overlay are shown on the official zoning map.

In addition to these design guidelines, all properties must conform to the underlying standards of the City's zoning ordinance. When a conflict exists between these design guidelines and the zoning ordinance, these design guidelines prevail.

1.2. Development Thresholds

It is expected to take many years for the Central Creek District to realize its vision. Due to the area's diverse ownership, change is expected to occur incrementally, rather than all at once.

For this reason, these design guidelines have been written so that the application of specific design standards has been tailored to the type of redevelopment proposed.

The following table applies in addition to the City's usual nonconformity provisions. When conformance is required by these thresholds, but not the citywide standards, these thresholds apply.

Symbols used in the table have the following meanings:

M = Mandatory conformance with the indicated part of these guidelines.

P = Partially mandatory conformance, which only applies to new improvements/alterations.

X = No mandatory conformance.

Chapter or Section	Redevelopment costs as a percentage of the fair market value of the structure			Land Disturbance of more than 25% of Site
	Less than 40%	40% to 75%	More than 75%	
Site Planning (except as below)	X	X	M	M
Pedestrian Entrance (2.14)	X	P	M	X
Walkway Access (L2.15)	X	M	M	M
Streetscapes	X	M	M	M
Building Design	X	P	M	X
Lighting	P	M	M	P
Site Furniture	P	M	M	P
Landscaping	P	M	M	P

KEY TERMS

The following terms have the indicated meanings when used in these guidelines:

- **Primary facade** means an exterior building wall that faces or is visible from a civic space or a street required to meet block size standards.
- **Secondary facade** means an exterior building wall that neither faces nor is visible from a civic space or a street required to meet block size standards. Traditionally, these facades have simpler design.

2. SITE PLANNING

Site planning guidelines control the general layout of redevelopment sites. They seek to establish a framework of streets and open space that support the creation of an increasingly walkable, mixed-use district. In addition, they ensure that the redevelopment of each site conforms to applicable City plans.

CONNECTIVITY

2.1. Organize sites into interconnected blocks.

- a. Create blocks with perimeters of no more than 2,400 feet. Smaller blocks are encouraged but not required.
- b. Define blocks with streets built to public standards, including all applicable streetscapes, except as specified for parking lots in "f" below.
- c. Locate new streets in accordance with any official City plans.
- d. Provide stub-streets to connect to adjacent sites within the Central District.
- e. Connect to any adjacent stub streets.
- f. Allow drives in parking lots to satisfy block standards if

streetscapes are provided on at least one side.

- g. In commercial areas, provide mid-block alleys between 16 and 24 feet in width to support access management guidelines.
- h. In residential areas, provide mid-block alleys at between 10 and 16 feet in width to support access management guidelines.

2.2. Support city trail and path plans.

- a. Locate non-vehicular trails and paths in accordance with any official City plans.
- b. Provide stub-trails to connect to adjacent sites within the Central District and connect to any adjacent stub trails.

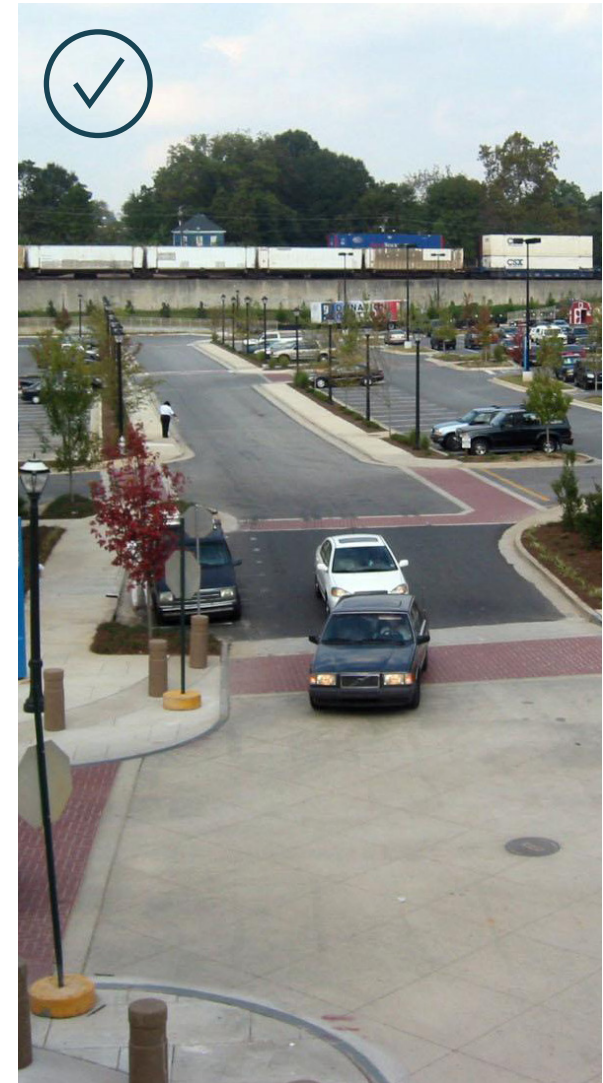

Drives in parking lots may define blocks when sidewalks are provided on at least one side.

ACCESS MANAGEMENT

2.3. Provide access management within development sites.

- a. Provide vehicular and pedestrian access between adjacent buildings and lots within developments.
- b. Provide shared vehicular ingress and egress between adjacent lots within developments.
- c. Design vehicular ingress and egress to provide a safe flow of traffic and to consider the safety and convenience of the pedestrian.

2.4. Provide access management between adjacent sites.

- a. Encourage vehicular and pedestrian access between adjacent sites.
- b. Encourage shared vehicular ingress and egress between adjacent sites.
- c. Require vehicular driveways and new streets to provide a safe flow of traffic and to consider the safety and convenience of pedestrians.
- d. Encourages adjacent landowners to enter into agreements providing access easements to accomplish the above.

In some cases, the City may ease other requirements of these design guidelines where shared access is utilized.

OPEN SPACE

The creation of open space, whether public or private, must be a focus of redevelopment in the Central Creek District. Open space will enhance the public realm and better the quality of life of residents and visitors.

There are two types of open space:

- **Open space** is defined by the zoning ordinance as, "any property designated, dedicated, or developed for use as a park, civic space, or outdoor open space for passive and active forms of recreation."
- **Amenity space** is defined by these guidelines any civic space (see page 9) plus publicly accessed areas improved for pedestrian enjoyment, including rooftop decks, outdoor dining, and at-grade common areas.

Amenity space excludes:

- Balconies, yards, pools, and spaces exclusively used by one dwelling unit.
- Parking lots tree islands.
- Required buffers, unless with a conforming civic space.
- Stormwater facilities, unless they are naturalistic in design and designed by a licensed landscape architect.

2.5. Incorporate planned open spaces.

Locate open and amenity space in accordance with any official City plans.



These adjacent commercial developments provide inter-parcel access.



Outdoor dining may be counted towards amenity space requirements.

2.6. Design developments around amenity space.

- a. Locate amenity spaces to provide focal points for developments.
- b. Avoid locating amenity spaces at the edge of sites, except when they buffer from residential areas or preserve existing features, such as creeks, ponds, wetlands, woods, or historic/archaeological sites.

2.7. Provide high-quality amenity spaces.

- a. Require development sites under 5 acres to provide amenity space equal to at least 5% of the site area.
- b. Require development sites 5 or more acres to provide amenity space equal to at least 10% of the site area.
- c. Locate ground level amenity spaces at-grade with adjacent streets for at least 15 feet of their depth to ensure visibility into them.
- d. Incorporate public art when otherwise required by the City's Public Art on Private Property standards. Amenity spaces provide a great setting for art that enlivens Goose Creek, promotes tourism, and reflects local history. Developers are encouraged to provide public art in a variety of media.

2.8. Implement and maintain open spaces.

- a. Finish amenity spaces before a certificate of occupancy is issued for immediately adjacent buildings. When a development contains multiple amenity spaces, this provision applies separately to each space to allow for a phased build-out.
- b. Require property owners or homeowners associations to maintain privately-owned open spaces.
- c. If an open space is given to the City and landscaping dies within the first year, replace it at the developer's expense within 6 months.



A square can serve as a focal point for local residents.



There is no minimum size for playgrounds. Courtesy City of Johns Creek.

Types of Civic Spaces

The types of Civic Spaces shown on this page may be used to satisfy amenity space requirements.

Images courtesy the Smart Code.

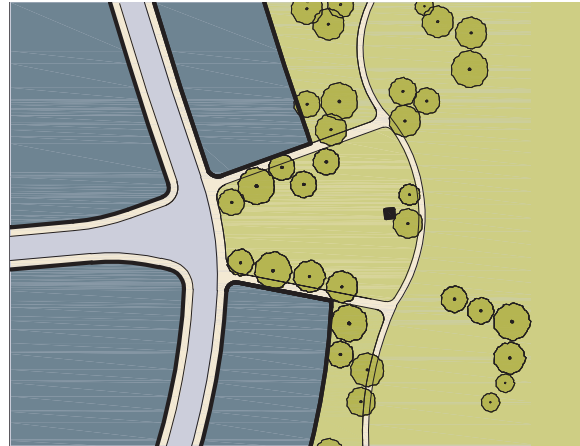

Park. An open space, available for unstructured recreation. A park's edges may be defined by landscaping rather than buildings. Its landscape should consist of paths and trails, meadows, woodlands, and trees, naturalistically disposed. The minimum size is 1 acre.

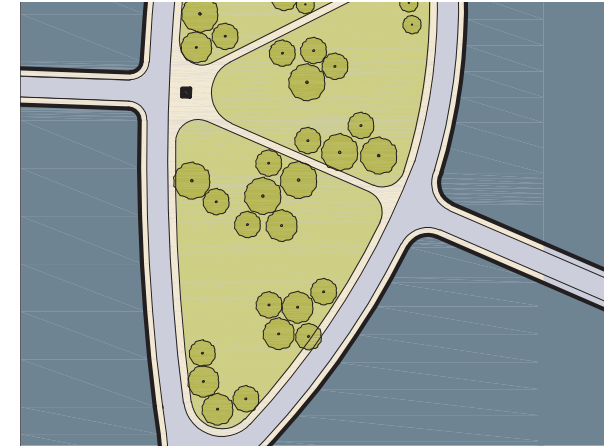

Green: An open space, available for unstructured recreation. A green may be spatially defined by landscaping rather than buildings. Its landscape should consist of lawn and trees, naturalistically disposed. The minimum size is 1 acre.

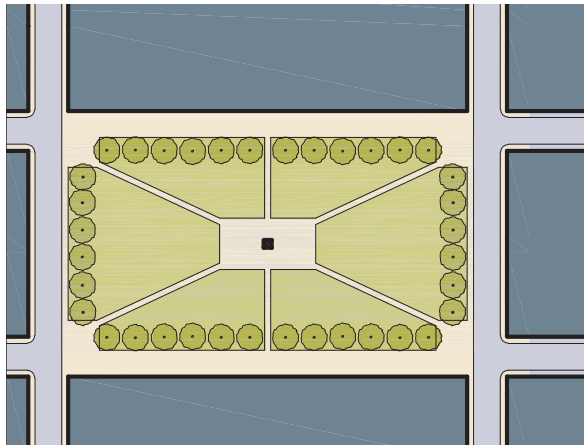

Square. An open space available for unstructured recreation and civic purposes. A square is spatially defined by buildings. Its landscape should consist of paths, lawns and trees, formally disposed. Squares should be located at the intersection of important streets. The minimum size is one-quarter acre.

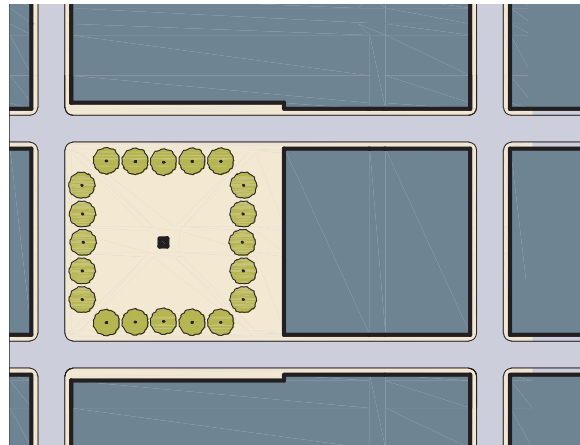

Plaza. An open space, available for civic purposes and commercial activities. A plaza should be spatially defined by buildings. Its landscape should consist primarily of pavement. Trees are optional. Plazas should be located at the intersection of important streets. The minimum size is one-quarter acre.

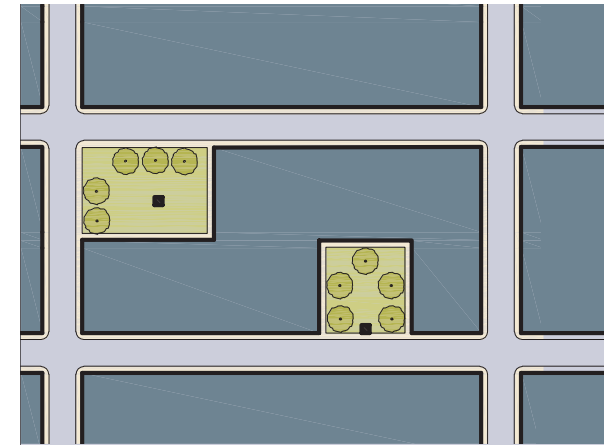

Playground. An open space designed and equipped for the recreation of children. A playground may include an open shelter.

Pocket Park. An open space available for passive recreation and relaxation. Pocket parks must include seating, trees, and other landscaping. There is no minimum size for either type.

BUILDING PLACEMENT

The following guidelines will help ensure that buildings properly address the street to enhance the public realm and provide convenient and safe access for pedestrians.

2.9. Locate new buildings close to the street.

- a. Locate buildings close to the sidewalk, with parking to the side or rear. Facades must be no more than 10 feet from the back of the required sidewalk.
- b. Locate buildings adjacent to the street intersection on corner lots.
- c. Design large stores, such as supermarkets, so that small buildings are located close to the street to screen parking and provide a pedestrian-friendly presence and scale.
- d. Place fuel stations so that fuel dispensing and service canopies are to the rear of the building and away from the street. These facilities and their queuing must not be visible from any public right-of-way or located within 25 feet of the back of the sidewalk.

2.10. Locate incremental improvements to anticipate future phases of development.

- a. Locate small-scale improvements to increase compliance with zoning standards and these guidelines. For example, an addition to an existing building must be located to enhance the street frontage and increase compliance with the maximum 10-foot front setback.
- b. Locate small-scale improvements to accommodate future vehicular and pedestrian connections. For example, parking areas and drive aisles may be set up to accommodate future redevelopment.

2.11. Locate and design incremental improvements to enhance the pedestrian environment of an existing development.

- a. Place improvements to enhance the pedestrian environment. For example, new buildings and open space areas shall be located to create a pedestrian gateway into the site.
- b. Plan for later pedestrian improvements, such as connections between the street and interior buildings, or to an adjacent site, when locating a new building or addition.

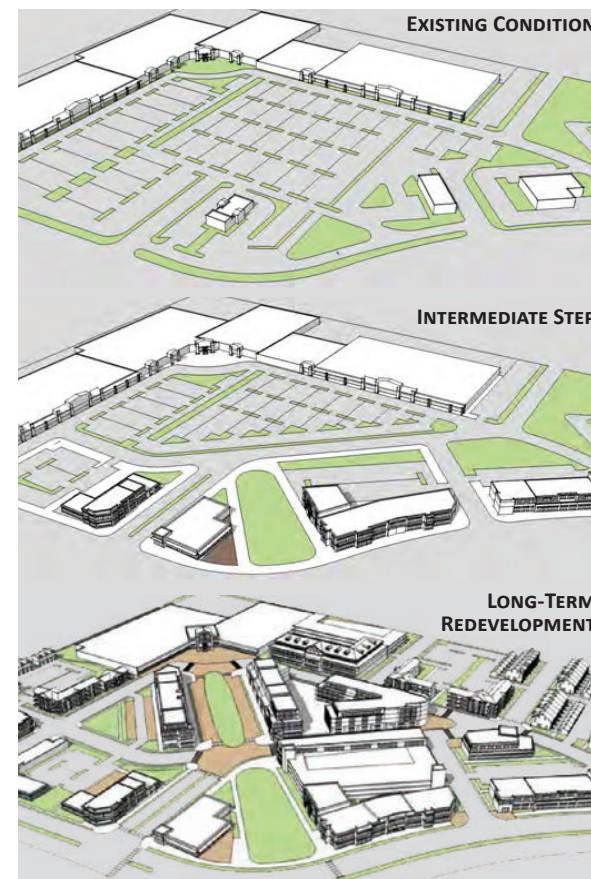

Redevelopment of existing sites, with short-term improvements anticipating later phases of development.

In the example above, new “pad site” buildings (middle) improve the edges of an existing shopping center site (top) as an intermediate step towards long-term redevelopment into a mixed-use center that incorporates some existing buildings (bottom).

Where an incremental improvement is consistent with the intent of the zoning ordinance and design guidelines, flexibility in the application of these guidelines is appropriate.

Image courtesy City of Roswell.

2.12. Vary building heights.

There are no building height limits, except as listed below:

- a. Use differences in roof form, parapet height, and number of stories on different modules along primary facades.
- b. Design 1-story buildings that have the massing and height of a 2-story building.
- c. Step taller building heights away from lower-scaled neighbors and provide a deeper front yard setback adjacent to smaller-scale buildings to encourage a comfortable pedestrian environment and helps new larger-scale buildings fit in.



Example of buildings at varied heights.

2.13. Provide active frontages along primary facades.

- a. Do not use the first 15 feet in building depth along a primary facade for storage areas, parking, or mechanical rooms.



Example of a building that steps back towards less intensive uses.

BUILDING ACCESS

2.14. Provide a pedestrian entrance.

- a. Provide a pedestrian entrance as follows:
 - i. Ground floor commercial uses adjacent to a street must have a primary pedestrian entrance which faces, is visible from, and is directly accessible from the adjacent sidewalk. The entrance must remain unlocked during business hours.
 - ii. Ground floor residential uses adjacent to a street must have a primary pedestrian entrance which faces, is visible from, and is directly accessible from the adjacent sidewalk.
 - iii. All ground floor uses must have address numbers at least 6 inches above the primary pedestrian entrance and clearly visible from the street.

2.15. Provide walkway access.

- a. Provide a walkway connecting from each primary pedestrian entrance required by "a" above to the closest sidewalk. The walkway must be at least 5 feet wide.
- b. Construct walkways through parking lots of surface pavers, such as brick, stone blocks, interlocking brick pavers, stamp

concrete or other materials as may be approved by the City. Materials must form a smooth surface but contrast visually and texturally with asphalt. For parking lots with fewer than 50 cars, the City may accept paint or similar markings.

- c. Line walkway with a landscape strip at least 5 feet wide on at least one side. The landscape strip must be planted with shade trees an average of 40 feet on-center.



A walkway connects from the public sidewalk to the primary building entrance.

STREETSCAPES

The following standards apply to all existing public streets and to new public and private streets used to satisfy the maximum block size requirements of these guidelines.

2.16. Enhance streetscapes.

- a. Provide areas for pedestrian activity between ground-floor commercial uses and the adjacent sidewalk. This may include amenity space.
- b. Provide landscaping between ground floor dwellings and the adjacent sidewalk, except for porches, stoops, or walkways.

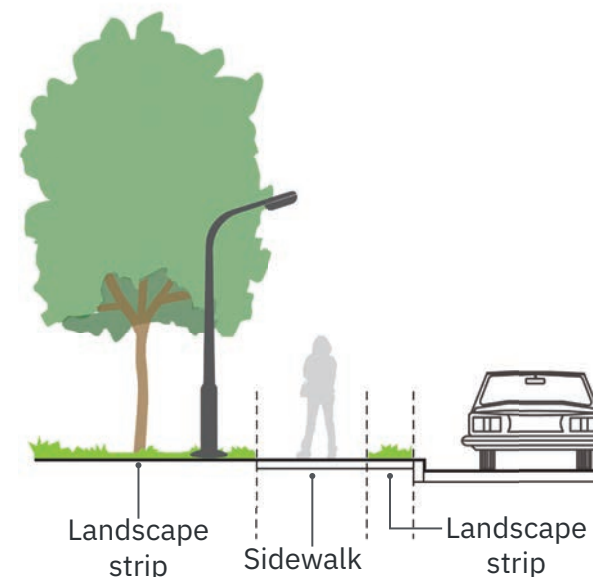

Typical streetscape elements (illustrative only)

- c. Install streetscapes along public and private streets as follows:
 - i. Minimum 8 feet wide sidewalk for commercial, civic, mixed-use, and multifamily uses, plus additional space where outdoor dining is planned; or
 - ii. Minimum 5 feet wide sidewalk for other uses.
 - iii. Minimum 5 feet wide landscape strip planted with street trees an average of 40 feet on-center at back of sidewalk.
 - iv. Minimum 2 feet wide landscape strip between sidewalk and the curb. The City reserves the authority to move the required street trees to this location under certain conditions, including when on-street parking is provided.
- d. Install streetscapes as specified in any official City plans in locations identified for such in lieu of "c".
- e. Design sidewalks to accommodate the safe, convenient flow of pedestrians.
- f. Do not obstruct the pedestrian flow on sidewalks with street furniture, dining, menu boards, outdoor dining, or other elements.
- g. Use crosswalk where a sidewalk crosses curb cut, such as driveways or service areas.

PARKING

2.17. Arrange parking facilities to support the district's vision.

- a. Do not locate parking or driveways next to intersections.
- b. Set all at-grade parking at least 20 feet from the back of the sidewalk.
- c. Provide one of the following between parking and the street:
 - i. A 20 feet wide landscape street, which may be in lieu of the 5-foot landscape strip required for streetscapes; or
 - ii. A building at least 15 feet deep.

- d. Arrange and design paving, curbs, open space, planting, fencing, lighting and cars with thought for aesthetics, users, and context.
- e. Channel pedestrians in parking lots of over 100 cars through a clear hierarchy of routes that brings them to central walkways. Reinforce this hierarchy through the design of planting and lighting.

2.18. Provide active frontages along primary streets in parking decks.

- a. Provide ground story active frontages at least 15 feet deep and with ceilings at least 14 feet high.

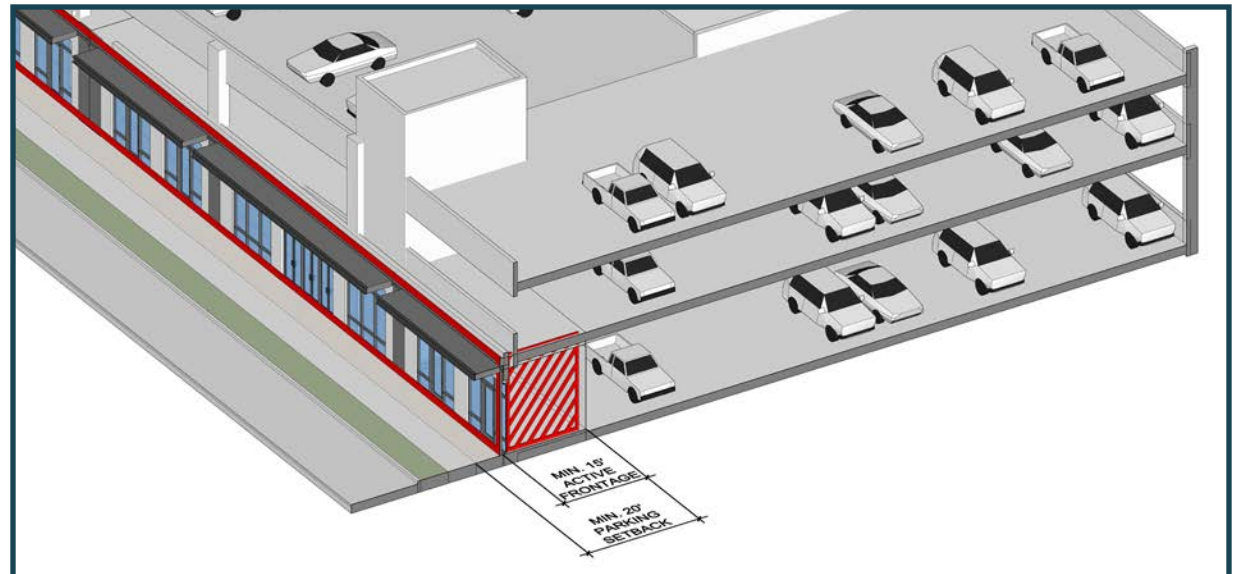

This illustration shows parking deck active frontage requirements.

2.19. Encourage on-street parking on existing and new streets.

- a. Count newly-created on-street parking towards the minimum parking requirements of the adjacent use.
- b. Provide curb-extensions/bulbouts at crosswalks, intersections, and other locations where on-street parking is provided.

PAVING

2.20. Incorporate permeable paving.

Pavement on roads, parking lots, sidewalks, paths, and other hardscaped areas will represent an ever-greater amount of land as development occurs in Goose Creek. Fortunately, pavement's environmental impact can be reduced.

Permeable (also called porous) surfaces are one way to do this. They provide the function and durability of pavement with the filtration benefits of soil. Oils, dirt, and other pollutants from streets and sidewalks that are washed away by rain can be allowed to filter into the ground instead of simply being channeled back into rivers and streams. This reduces flooding, infrastructure costs, and the amount of pollutants typically found in stormwater. This pavement also allows surface water to infiltrate into the groundwater. With less water on the

street, the occurrence of hydroplaning and similar rain-related traffic accidents are also reduced.

There are a variety of porous paving materials. Guidelines are as follows:

- a. Encourage porous pavement or open grid pavers in parking lots, driveways, and alleys to decrease stormwater runoff. Maintenance is relatively minimal.
- b. Use crushed stone in plazas or parks to provide a hard surface for pedestrians but allow rain water to filter through.
- c. Use colored pavers to distinguish crosswalks on otherwise stone or gravel surfaces.
- d. Encourage use of the following pervious materials
 - i. Open grid pavers
 - ii. Grass pavers, especially in overflow parking areas or fire access lanes
 - iii. Interlocking concrete paving blocks with a sand base, especially for sidewalks, civic spaces, and patios



Porous concrete allows water to filter into the ground.

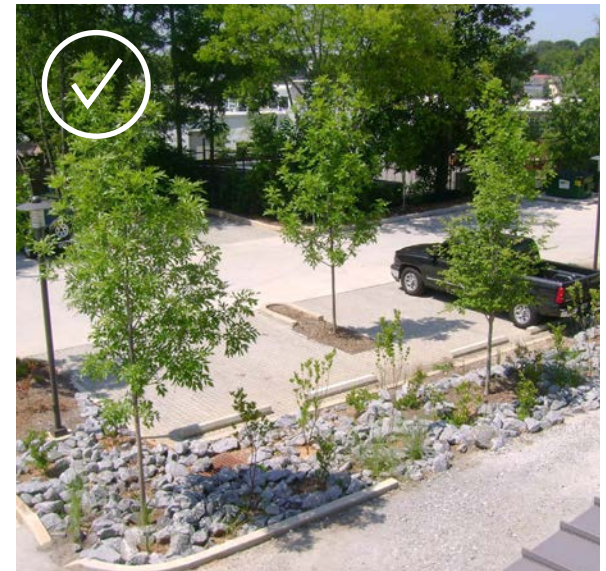

Pervious surfaces can decrease stormwater runoff in parking lots, driveways, and alleys. Courtesy Trees Atlanta.

SCREENING

Utilities and service areas are a necessary part of all modern buildings, but should be constructed and located to minimize their visual impact.

2.21. Use screening that is compatible with the principal building.

When screening is accomplished through fences or walls, the materials should be compatible with the principal building in terms of design, color, and materials.

2.22. Reduce the visual impact of utilities.

- a. Reduce the impact of overhead utility lines by relocating them behind buildings, in alleys, or underground.

Where utilities cannot be buried or relocated, street trees should be limited to those specified in Chapter 7.

Locate utility equipment, such as back flow preventers, meters, telephone pedestals, and electrical transformers to minimize their visual impact on the street and surrounding properties. Where not possible, screen them.

- b. Do not locate Transformers or pedestals and significant pedestrian or amenity areas or near building entries.

2.23. Reduce the visual impact of refuse and service areas.

- a. Do not locate dumpsters and trash compactors between a building and an adjacent street. They must be screened and may not be visible from any public right-of-way or other pedestrian area.
- b. Screen trash containers and dumpsters from view on all sides with a 6 feet high fence or wall. Keep gates closed unless in use.
- c. Locate trash areas for convenience of trash collection and away from major streets.
- d. Keep loading areas clear from pedestrian and vehicular traffic.
- e. Locate service areas and loading areas to minimize their visual impact on the adjacent streets and properties. Service and loading areas must be screened.
- f. Locate refuse areas to minimize their visual impact on the adjacent streets and properties. Refuse areas must be screened. Where possible, adjacent uses should share refuse area enclosures.

2.24. Reduce the visual impact of outdoor storage.

Do not locate outdoor storage areas between a building and an adjacent street.



This dumpster screening is compatible with the design of the principal building.



An unscreened dumpster is not appropriate. Courtesy Dan Keck.

2.25. Reduce the visual impact of mechanical equipment

- a. Locate at-grade air conditioning units, meters, transformer boxes, and similar equipment to the side or rear of buildings and screened with a wall or evergreen plant material so as to be invisible from a street.
- b. Locate or screen roof-mounted mechanical equipment so that it is not visible from any street.
- c. Screen antennas and satellite dishes.
 - i. Roof mounted antennas and satellite dishes are not discouraged as long as they are not visible from the street.
 - ii. Other satellite dishes, antennas, connecting cables and wiring are considered unsightly and should be kept from the view of the street. Screening of these devices must conform to rooftop mechanical screening. No satellite dishes or antennas are permitted on a primary facade.

2.26. Reduce the visual impact of outdoor sales.

- a. Screen permanent outdoor sales areas, such as garden centers.
- b. Locate vending machines where they are not visible from the street.

STORMWATER FACILITIES

2.27. Use innovative stormwater management techniques.

- a. Encourage buried, shared, and low-impact stormwater facilities.
- b. Grade sites in such a way that it does not promote excessive run-off or erosion.



This park doubles as the development's stormwater detention facility.

This page has been intentionally left blank

3. BUILDING DESIGN

Intent of Building Design Guidelines

The primary intent of building design guidelines is to reinforce a sense-of-place for the Central Creek District. The standards encourage construction that is straightforward and functional, and that draws its ornament and variety from the traditional assembly of genuine materials.

The guidelines also strive for buildings that support human activity and unify the District's experience and character. Central to this is providing a sense of human scale. A sense of human scale is achieved when a person can reasonably interpret the size of a building by comparing its features to comparable elements from their experience. Using materials with a familiar dimension such as traditional brick is an example, as is using windows of similar dimensions.

Applicability

These guidelines are intended to apply to all buildings in order to establish a common "downtown" form, regardless of use. Despite this, there may be times when a more "residential" character is appropriate, such as transitioning to nearby neighborhoods or on the interior of blocks. For these cases, limited alternative residential standards are provided but should never be applied along existing public streets.

MASS, SCALE, AND HEIGHT

Mass is the relationship between the height and width of a building and the nature of its roof line. Consistent massing helps to provide a streetscape with a sense of unity. Massing can also emphasize corners and entrances and create interesting roof lines.

A traditional downtown is usually made up of narrow buildings 20 to 40 feet wide that provide a human scale and visual interest. When larger buildings exist, they are often ornamented to provide visual interest.

The following standards seek to recreate this fine-grained character along existing streets in the Central Creek District.

3.1. Harmonize relationships between buildings, streets, and open spaces.

- a. Modulate building massing vertically and/or horizontally to a scale compatible to its context.
- b. Shape development to respond to topographic changes, and blend naturally into the landscape.
- c. Avoid irregular footprints or complex shapes, which disturb the continuous streetscape.
- d. Avoid "big box" architecture – single large structures with monolithic appearance.



This single building achieves the appearance of several smaller buildings through a variety of techniques, including: change in facade materials and color, change in windows, change in roof form, change in facade style, and change in finished floor elevation

3.2. Break up primary facades into smaller modules.

- a. Create visual interest using one of the following techniques:
 - i. Divide primary facades into 20 to 60 feet wide modules that have the appearance of separate buildings built over time; or
 - ii. Apply architectural ornament to larger modules up to 200 feet in length.
- b. Distinguish adjacent modules by changing the following:
 - i. Exterior materials, extending from grade through the cornice;
 - ii. Storefront systems;
 - iii. The number of stories;
 - iv. Window systems;
 - v. Building styles; or
 - vi. Similar means that convey separate buildings.

Change in color, building ornament, or setback alone is not allowed.

- c. Within a module, provide visual divisions between the first and second floors, where applicable. This can be done by adding courses, awnings, or a change in materials. Provide a ground story storefront. (see Building Elements)



Traditional downtowns usually are made up of narrow buildings.



In traditional downtowns, larger buildings are highly ornamented to retain visual interest.

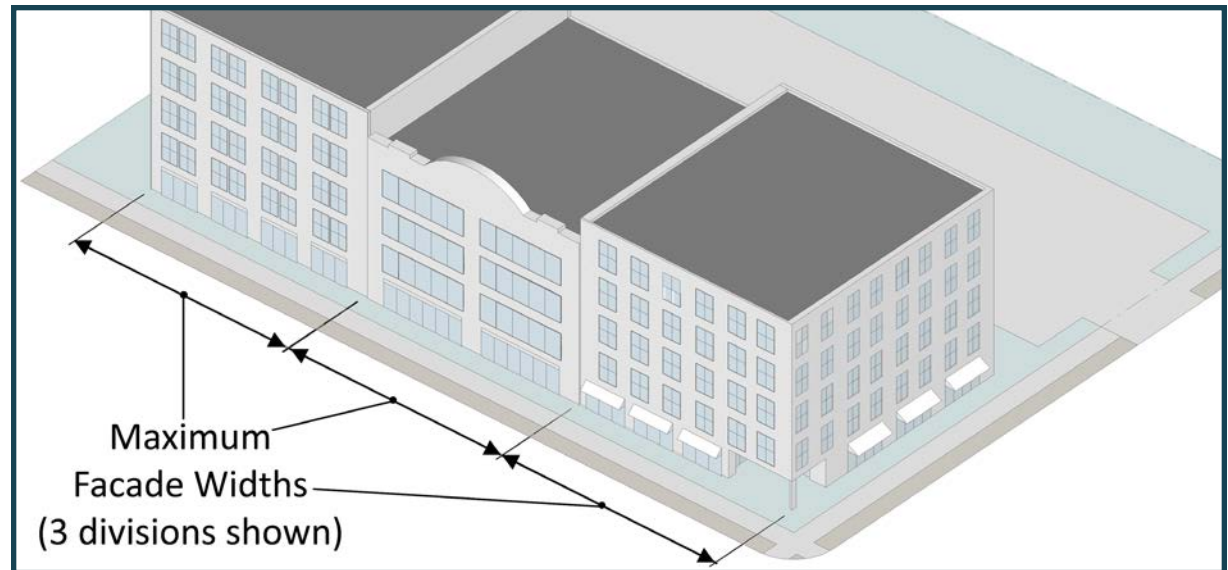

Example of a building broken up into three separate modules, each 60 feet in width.

- d. Provide two- or three-part facades on buildings taller than two stories. Horizontal facade zones may be differentiated by a change in materials, window pattern or materials, or a cornice or course.

A two-part facade consists of:

- i. Base zone (ground story).
- ii. Shaft zone (all other stories).

A three-part facade consists of:

- i. Base zone (ground story).
- ii. Shaft zone (middle stories).
- iii. Cap zone (upper stories or cornice).

- e. Within a module, use one or more of the following to articulate the facade:

- i. Recesses.
- ii. Projections.
- iii. Articulated structural bays.
- iv. Pilasters or other architectural ornaments.
- v. Recessed windows.

The goal is to avoid a facade that looks "flat" by adding depth and shadows.

The diagram at right illustrates the three facade zones. Note the visually "heavier" material is placed beneath the "lighter" material. Representative images are shown below.



3.3. Emphasize primary facade corners.

- a. Treat building corners, particularly at intersections, to facilitate pedestrian movement and to enhance main intersections.
- b. Use corner returns at least one architectural bay long along an alley or block break before changing materials and detailing. As used here, “return” means to carry a material or detail past a corner and into an adjacent facade.

3.4. Allow simpler secondary facades.

- a. When a development includes multiple buildings, do not apply primary facade standards to exterior walls that are temporarily visible from a street but will eventually be screened by an intervening building.

PRIMARY FACADE DETAILS

3.5. Provide walls with visual depth.

- a. Design building walls to have perceivable thickness, visual interest and character.
- b. Use reveals and offsets to create shadow lines and break up large flat monotonous surfaces.

3.6. Use architectural details that are consistent with the style.

A selection of architectural details appropriate to the architectural style can create shadows and texture adding to the character of the streetscape.

- a. If expression lines and cornices are installed, use either molding extending a minimum of 2 inches, or jogs in the surface plane of the wall greater than 2 inches.
- b. If ground floor awnings and marquees are used, install them below the expression line within the base zone.
- c. Apply trim, metal- and woodwork, lighting, and other details in a harmonious manner, consistent with the proportions and scale of the building.



Corners are often traditionally emphasized in building design.



Design building walls to have perceivable thickness, visual interest and character.

ROOFS

3.7. Design roofs with the same intent as building facades.

In addition to providing building protection, the roof is also a basic architectural element that defines the character of the space it protects.

- a. Use roof slopes appropriate to the building style.
- b. When a sloped roof is used, provide a pitch of between 5:12 and 12:12. This does not apply to dormers, porches, and roofs not visible from a street.
- c. When a flat roof is used, vertically screen it with a parapet wall along all facades.
- d. Paint vents and stacks to match roof materials and conceal from view along primary facades.
- e. Use cornice returns appropriate to the building style.
- f. Match downspouts with gutters in material and finish.
- g. Use varying roof levels and forms on large structures to decrease mass and create diversity.
- h. Do not use unusually steep roofs, such as “A” frames or mansard roofs.

WINDOWS & DOORS

Windows and doors are key elements of building design. They not only provide access, ventilation and light, their placement, design, size, shape, and orientation add to the appearance of a building. They even contribute to lively and safe civic spaces and streets.

3.8. Emphasize window and door design on primary facades.

- a. Incorporate windows and doors by providing:
 - i. At least 75% glass for ground story storefronts (see Building Elements).
 - ii. At least 20% glass for other ground story nonresidential uses.
 - iii. Between 20% and 60% glass for upper story nonresidential uses.
 - iv. Between 10% and 60% glass for all residential stories.

The percentages above are calculated separately for each story along a given facade.

Alternative standards are appropriate for civic buildings, such as school, libraries, religious facilities, which traditionally have fewer windows and doors.

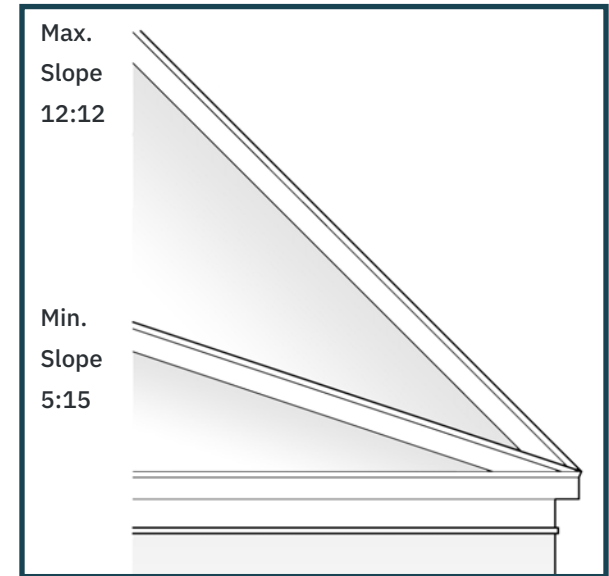

Civic buildings traditionally have fewer windows and doors than private buildings.

- b. Enhance primary entrances with architectural surrounds, porticoes, or other design features appropriate to the architectural style of the building.
- c. Provide the following on upper stories:
 - i. Even horizontal spacing for windows on a given story.
 - ii. Either the same size windows on all given story, or windows that decrease in size from the base to the cornice.
 - iii. Horizontal alignment of window grids across all stories from the base to the cornice.
 - iv. Casement, double-hung, industrial, or fixed frame windows.

- d. Use rectangular windows arranged vertically. These are not required for storefronts, transoms, or top story windows when appropriate to the architectural style.
- e. Use window designs that create depth and shadow as follows:
 - i. For divided lights, use muntins that project from the glass on both sides (interior and exterior)
 - ii. Enhance shadow lines around openings by recessing window frames 2 inch minimum from the face of the building.
- f. Encourage painted wood or aluminum wood clad windows for residential application.



Do not use windows that are not recessed into the facade.

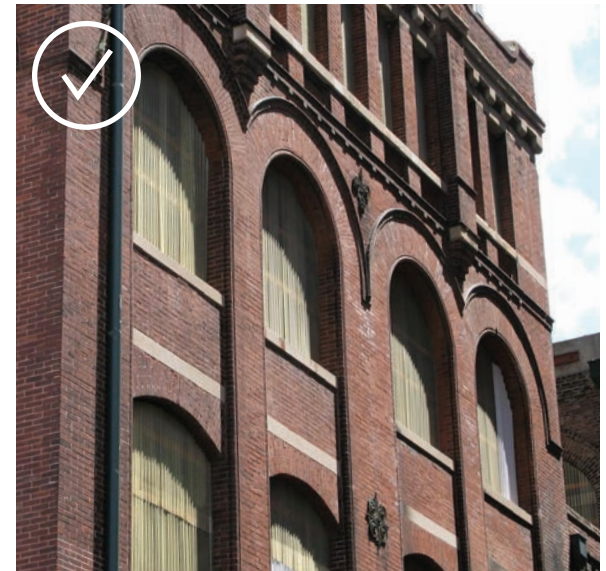

Recessed windows create shadows and give the facade a sense of depth.



Appropriate simulated divided windows with muntins attached to both sides.

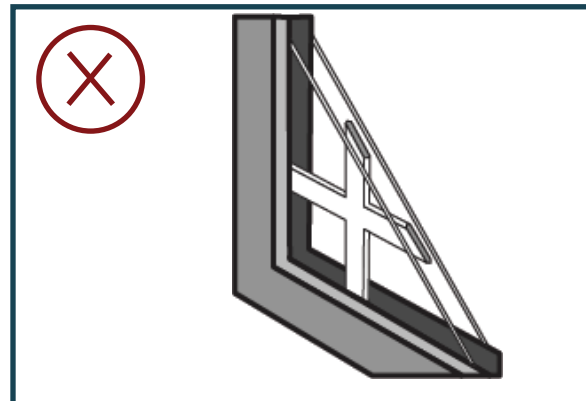

Inappropriate grid-between-glass windows.

3.9. Use transparent glass on required windows and doors.

- a. Use glass with a transparency higher than 80% and external reflectance of less than 15%.
- b. Encourage awnings and similar features over storefronts to achieve even higher glass transparency and reflective, as allowed by energy codes.
- c. Do not paint glass, apply films to glass, or use other physical means to alter transparency.

3.10. Do not use the following on window and door.

- a. Grids-between-glass.
- b. Vinyl, snap-in mullions.
- c. Exterior security bars, steel gates, and steel roll down curtains.
- d. Rope lighting.
- e. Residential doors in commercial buildings.

MATERIALS & COLORS

Facade materials support a sense-of-place and comfort. Facade materials should be durable, low-maintenance and have a natural color. A defined palette of materials will unify the Central Creek District and encourage the perception of permanence.

3.11. Use traditional materials and combinations.

- a. Limit facade materials to full-depth brick, natural stone, cast stone, terra cotta, decorative concrete block within integral color, pre-cast concrete resembling brick or stone, or true hard coat stucco. Accent materials may include ceramic tile, galvanized steel, glass block, wood, stone or stucco. See "g" for additional restrictions.

In addition to the above, horizontally arranged wood and cementitious clapboard siding are allowed on single-family dwellings.

- b. Use changes in material to express human scale while assuring that the overall composition of the building design remains intact and does not appear overly busy.
- c. Combine materials only horizontally, with the visually heavier below the lighter.
- d. Construct modules of no more than three primary materials and/or colors. Additional materials may be used as trim or accent materials; however, the use of an excessive number of materials risks creating a module that is inconsistent with the intended character.



Unpainted brick, unpainted stone, and unpainted terra cotta are appropriate for the Central Creek District.

- e. Use material with regard to their traditional structural capacity.
- f. Face exposed foundation walls (below the first floor elevation) in concrete (painted or stuccoed), brick, or stone.
- g. Do not use:
 - i. Painted stone, brick, or masonry.
 - ii. Large panelized products or other materials that produce extensive featureless surfaces.
 - iii. Metal exterior wall cladding panels, corrugated metal, , shipping containers, or pre-engineered metal buildings.
 - iv. Vinyl or aluminum siding.
 - v. Exposed concrete masonry units.
 - vi. Reflective materials that cause glare.
 - vii. Materials that artificially simulate natural materials.
 - viii. Exaggerated swirled stucco.

3.12. Use colors that reinforce a sense-of-place.

A defined, limited palette of harmonious colors helps to determine character and unify an area.

- a. Use hues from or equivalent to any historic palettes from any major paint manufacturer for exterior wall finishes, foundations,

windows, and doors, but do not use:

- i. Primary and fluorescent colors.
 - ii. Dark colors that eliminate shadow patterns.
- b. Allow colors other than those allowed by "a" above for accents but not exceeding 10% of the total facade wall area.
 - c. Use white or reflective paint on rooftops and light paving materials to reflect heat away from buildings and reduce the need for mechanical cooling.

3.13. Use roofing materials that reinforce sense-of-place.

- a. Finish roofs in asphalt, fiberglass, or cedar shingles, concrete or clay tile, slate or simulated slate, or standing seam metal.
- b. Allow additional materials on flat roofs that are not visible from the street.
- c. Require roofing materials to have a minimum usable life of 30 years according to the manufacturer’s warranty.



Primary colors, dark colors, and more than three colors and/or materials are not allowed.



Because this buildings flat roof is screened by a parapet wall, it may be of any material.

BUILDING ELEMENTS

Building elements are common ways of applying windows, doors, and other elements to facades.

3.14. Design building elements as described in these guidelines.

See pages 26 through 28.

Storefronts

The storefront is the basic unit that typically makes up a “downtown” environment. A storefront is defined as ground story active frontage space along a sidewalk. Its purpose is to facilitate the sale of goods and services to passing pedestrians. Therefore, transparency is important to allow for maximum visibility. The storefront also provides natural ventilation and light into a typically long narrow space.

A recessed entry provides shelter in inclement weather, and a safer exit by providing door swing space. Primary entrances should be oriented to the street and clearly recognizable. Continuous storefronts with frequent entries create an active pedestrian oriented environment.

- Use ground story storefronts along all primary facades. Limit the length facade without any intervening glass or door to 20 feet.
- Use traditional storefront design with large areas of glass with minimal mullions.
- Provide at least 75% glass for ground story storefronts.

- Provide display window glass beginning at between 6 inches, and 2 feet above grade, and extending to between 11 and 12 feet above grade.
- Provided a 2 to 3 feet high transom window above the display window.
- Provide an entrance for each use along the sidewalk.
- Recess the entrance door, when possible.
- Provide windows equally sized, taller than they are wide, equally spaced, and arranged in a grid pattern.
- Create a focus or sense of entry, clearly defined location of the front door.



Porches

Porches are only appropriate for residential uses, when allowed.

- a. Provide at least 8 feet in depth.
- b. Provide at least 80% of facade width.
- c. Allow one- or two-story.
- d. Do not enclose with glass.
- e. Install any frame and screening inside columns and railings. Screen doors must be composed primarily of screen – no half-screen/half-solid doors. The color of framing for porch screening is determined by the trim of the main building.
- f. Encourage wraparound porches for corner lots.
- g. Raise porches unless wheelchair access is desired.

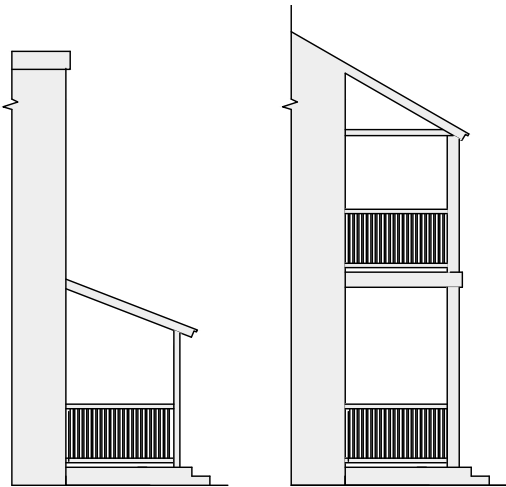

Stoops

Stoops are only appropriate for residential uses, when allowed.

- a. Provide at least 4 feet in depth and width.
- b. Raise stops unless wheelchair access is desired, but not more than 6 feet above grade.
- c. Do not enclose, unless stoop is recessed into the main building.
- d. Allow covered or uncovered stoops.
- e. Run stairs perpendicular or parallel to the facade.

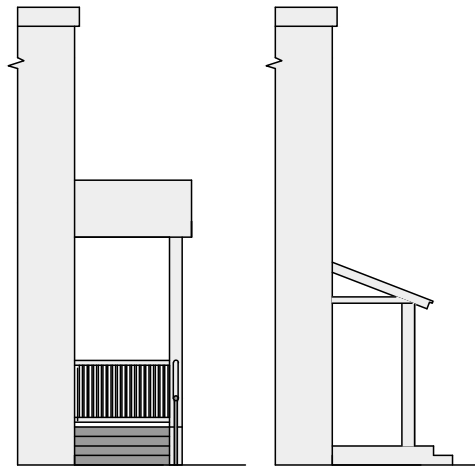

This photos shows a porch on a "residential" building design, rather than a "downtown" one.



This photos shows stoops on townhouses designed to look like "downtown" buildings, rather than "residential" ones.

Awnings and Canopies

For the comfort of the pedestrian, awnings and canopies are encouraged. Shelter at the entrance of a building provides protection from the sun and rain, and helps to define pedestrian scale along a streetscape.

Awnings also provide a place for signage or graphics, but the only area allowed for this use is the vertical face or valance portion of the awning.

- a. Provide at least 5 feet in depth.
- b. Provide at least 9 feet of clearance above the ground.
- c. Style awnings and canopies consistent with the architectural style of the building.
- d. Only place awnings or canopies over windows, doors or openings.
- e. Use awnings and canopies to accent the building's design but not be the dominant architectural feature.
- f. Provide awning and canopy frames or support of painted or coated metal or other non-corroding material.
- g. Limit awnings to a single color or two-color stripes.
- h. Only use water-resistant canvas on awning.
- i. Allow marquees and metal canopies

- j. Do not use:
 - i. Back-lit awnings or canopies.
 - ii. Awnings or canopies in a continuous band around the building.
 - iii. Fixed supports that can interfere with pedestrian circulation.

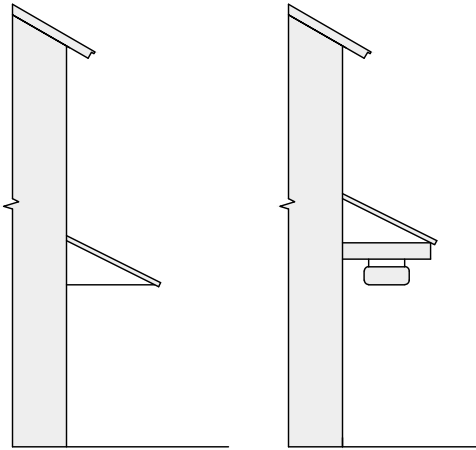

BUILDING STYLE

3.15. Design buildings in the mercantile style.

See page 29.

3.16. Do not use corporate or franchise architecture.

Typically, franchise architecture is generic design, buildings used in multiple locations without consideration for a specific site or climate. It is the intent of these guidelines to create buildings that are sensitive to their environment. While franchise merchants are not discouraged, prototypical design must be carefully modified to represent the character of the downtown context.

MERCANTILE STYLE BUILDINGS

Overview

Elements of the mercantile style include:

- Front facades are symmetrical, except for asymmetrical doors historically used to access upper story uses.
- A tower element may be included for structures over three stories.
- Brick/masonry that vary in color and texture should be the primary material.
- Roofs are flat or sloped.
- Ornamentation is subordinate to large windows.
- The base is delineated by entrance detailing that may include large storefronts at street level.

This said, mercantile is not a true style as much as a way of designing commercial, mixed-use, mill, and railroad buildings across many decades and design trends.

As a result, the style can be expressed in an either highly detailed traditional way or more simplified modern approach.



These images show how mercantile primary facades are organized. Note the “heavier” material is placed beneath the “lighter” material.



Facades

Aluminum storefront systems are permitted in the base zone. However, painted wood trim (with painted wood doors and window surrounds) are preferred. The shaft zone must be limited in material choice.

Unpainted brick should be the primary material for this style but other material as listed in the materials section of these guidelines may also be considered.

Balconies, Porches, and Patios

Exterior features such as balconies, canopies, and patios must be composed of metal. The metal must be a similar color tone that complements the shaft zone. Wood, plastic, and vinyl are not permitted.

Projecting balconies on primary facades are discouraged.

Windows

Windows, except storefronts, may have a variety of designs. Individual or ganged vertical rectangular windows with a variety of sash divisions are allowed in order to reflect the style's nineteenth century roots.

Alternatively, large, multi-division windows are allowed when drawing inspiration from twentieth century designs.

Additional Features

If provided, chimneys may not be visible from a street or civic space.





3: Building

REPRESENTATIVE APPLICATION OF GUIDELINES

The diagram at right shows the same development without (top) and with (bottom) conformance with the building standards in these design guidelines.

Noticeable changes include:

- The division of the facade into discrete modules that have the appearance of separate buildings built over time.
- The use of the mercantile style.
- The use of 3-part facades.
- The use of brick and masonry.
- The use of ground story storefronts and stops.
- The use of between 20% and 60% glass on upper stories.

The top design does not conform with building design guidelines



The bottom design does conform with building design guidelines



Note:

These renderings are illustrative only and are not intended to comply with all aspects of the proposed Central Creek District Design Guidelines.



3: Building

4. LIGHTING

PARKING LOT LIGHTING

- 4.1. Provide the minimum amount of parking lot illumination to serve users and promote public safety.**
- a. Install parking lot lighting that:
 - i. Is not obtrusive in appearance during the daytime.
 - ii. Provides adequate lighting without significant glare.
 - iii. Does not interfere with tree canopies.
 - b. Use cut-off or shoebox fixtures in a dark color such as black or bronze.
 - c. Do not use low-pressure sodium luminaries.

STREET LIGHTING (PUBLIC)

- 4.2. Provide street lighting along public streets and sidewalks as required by City code and the following standards.**
- a. Install street lighting that:
 - i. Is not obtrusive in appearance during the daytime.
 - ii. Provides adequate lighting without significant glare.
 - iii. Does not interfere with tree canopies.
 - b. Use cut-off or shoebox fixtures in a dark color such as black or bronze.
 - c. Do not use low-pressure sodium luminaries.

STREET LIGHTING (PRIVATE)

- 4.3. Provide street lighting along private streets and sidewalks as required by City code and the following standards.**
- a. Install street lighting that:
 - i. Is not obtrusive in appearance during the daytime.
 - ii. Provides adequate lighting without significant glare.
 - iii. Does not interfere with tree canopies.
 - b. Use decorative fixtures with a pole height not to exceed 16 feet (12 feet is optimal) in a dark color; black or bronze are preferred.
 - c. Do not use low-pressure sodium luminaries.

BUILDING/STRUCTURE LIGHTING

4.4. If buildings and structures are illuminated, comply with the following:

- a. Use externally mounted fixtures equipped with adequate shields or baffles to prevent significant glare or hot spots. Up lighting, or accent lighting for the purpose of illuminating buildings and other physical site features is encouraged.
- b. Do not use low-pressure sodium luminaries.

SIGN LIGHTING

4.5. If signs are lit, comply with the following:

- a. Use externally mounted fixtures equipped with adequate shields or baffles to prevent significant glare or hot-spots.
- b. Do not use low-pressure sodium luminaries.
- c. Do not use back-lit signs.

BUILDING-MOUNTED LIGHTING

4.6. If building-mounted lighting is used, comply with the following:

- a. Use externally mounted fixtures equipped with adequate shields or baffles to prevent significant glare or hot-spots.
- b. Use non-obtrusive fixtures or complimentary to the overall design of the building.
- c. Do not use low-pressure sodium luminaries.

LANDSCAPE LIGHTING

4.7. If landscape lighting is used, comply with the following:

- a. Design to prevent significant glare or hot spots, whether ground-mounted or tree-mounted, landscape lighting.
- b. Do not use low-pressure sodium luminaries.



Unshielded lights are not allowed. .



External mounted sign lighting.

5. PRIVATE SITE FURNITURE

Consistent and complementary site furniture is important to establishing a sense of place.

The following site furniture is recommended for private applications, such as in private civic spaces or amenity areas, unless otherwise noted.

All site furniture on City land must conform to City of Goose Creek standards.

BENCHES

5.1. Incorporate benches into private amenity and civic spaces.

- a. Locate benches to provide opportunities for a variety of activities from waiting or resting to reading or socialization. Bench location should be integrated into the overall design and recognize the convenience and comfort of the user.
- b. Do not locate benches and trash receptacles immediately adjacent to each other due to concerns of odors and insects.
- c. Do not locate benches where they will:
 - i. Impede pedestrian or vehicular circulation;
 - ii. Impede sight lines; or

- iii. Where they would conflict with landscape maintenance equipment or emergency vehicle access.
- d. Use benches that are durable enough to withstand the rigors of a public location. Metal is preferred. Wood can be used in some situations. Plastic is not recommended.
- e. Use the recommended benches found on this page or similar. The use of specific brands is not required.

Recommended options:

Landscape Forms, Inc. – Scarborough
431 Lawndale Ave.
Kalamazoo, MI 49048
(800) 430-6209

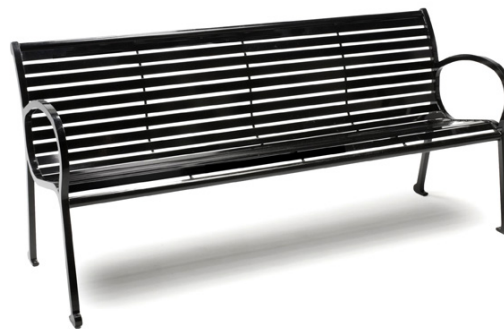

Columbia Cascade Company – No. 2118-6 TimberForm® Restoration Bench with Armrests
1975 SC Fifth Ave.
Portland, OR 97201-5293



OUTDOOR DINING

5.2. Use durable outdoor dining furniture.

- a. Use attractive, commercial-grade, durable, weather-resistant, low-maintenance outdoor dining furnishings in a design that is complimentary with the building and function that they serve.
- b. Encourage complementing outdoor dining areas with landscaping and trees.



Outdoor dining furniture must be commercial grade.

TRASH RECEPTACLES

5.3. Provide trash receptacles in developments.

- a. Integrate trash receptacle locations into the overall design of a space and recognize the convenience and safety of the user.
- b. Do not locate benches and trash receptacles immediately adjacent to each other.
- c. Locate trash receptacles in areas such as near building entries and intersections of two walkways.
- d. Due to possible odors and insects, do not locate trash receptacles immediately within an area where people will gather or linger.
- e. Do not locate trash receptacles where they will:
 - i. Impede pedestrian or vehicular circulation;
 - ii. Impede critical sight lines; or
 - iii. Where they would conflict with landscape maintenance equipment or emergency vehicle access.
- f. Use the recommended trash receptacle found on this page or similar. The use of specific brands is not required.

Recommended:

Victor Stanley Ironsides® Series 42 36-gallon trash receptacles

Standards spun-steel lids and “Black” baked-on polyester powder finish.



VICTOR STANLEY® Create a timeless moment.®
Product may be patented. Visit VICTORSTANLEY.COM for details.

KIOSKS

5.4. If kiosks are installed, conform with the following standards.

- a. Locate information kiosks near the intersection of two walkways or in other areas where there is a high concentration of pedestrian traffic. Information Kiosk locations should be integrated into the overall design of a space and recognize the convenience of the user.
- b. For one-sided kiosks, place the structure in a groundcover or shrub bed within 1 foot of the edge of paving. For multi-sided kiosks, a minimum of 6 feet should surround all sides of the information kiosk.
- c. Do not locate kiosks where they will:
 - i. Impede pedestrian or vehicular circulation;
 - ii. Impede critical sight lines; or
 - iii. Where they would conflict with landscape maintenance equipment or emergency vehicle access.
- d. Use any design of information kiosk, provided it is durable, low maintenance and vandal resistant.

BICYCLE RACKS

5.5. If bicycle racks are installed, conform with the following standards.

- a. Locate short-term use bicycle racks near the entry to all major buildings.
- b. Integrate bicycle racks into the overall design and recognize the convenience and comfort of the user.
- c. Do not locate bicycle racks where they will:
 - i. Impede pedestrian or vehicular circulation;
 - ii. Impede critical sight lines; or
 - iii. Where they would conflict with landscape maintenance equipment or emergency vehicle access.
- d. Use the recommended bicycle rack found on this page or similar for application in streetscapes or walkways. The use of specific brands is not required.

Recommended:

The Park Catalog – U Bike Rack: 1-7/8” O.D. In-ground mount, Black Powdercoat
220 Congress Park Drive, Suite 215
Delray Beach FL 33445



There are no specific standards for bicycle racks not located within a streetscape.



FENCES, WALLS & GATES

5.6. If fences, walls, and gates are installed, conform with the following standards.

- a. Limit nonresidential fences to the recommendation found on this page or similar. Brick or masonry columns may be provided. The use of a specific brands is not required.
- b. Limit residential fences and gates to painted wood, composite materials, natural or synthetic stone, or black wrought iron with the finished side facing the street.
- c. Do not use chain link or wire fencing where visible from a street.
- d. Space any brick or stone columns no more than 40 feet apart.
- e. Limit walls surrounding outdoor dining or displays in the sidewalk or front yard to a maximum height of 32 inches unless a higher wall is required by another City code. All other walls in the front yard, except retaining walls, are discouraged.
- f. Plant shrubs and trees around fences in highly visible areas.
- g. Construct walls in a manner and of materials, which are complimentary and visually compatible with their surroundings.
- h. Limit wall materials to natural stone, cast stone, brick, or smooth stucco.
- i. Avoid long uninterrupted lengths of fence or walls to minimize monotony.
- j. Maintain all walls and fences.

Recommended:

Ameristar – Montage Industrial

Majestic, 2-Rail, In-ground mount, Black Powdercoat
3717 Mercy Star Court
Orlando, Florida 32808



DRINKING FOUNTAINS

5.7. Incorporate drinking fountains into civic spaces.

- a. Integrate drinking fountain locations into the overall design of civic spaces and recognize the convenience of the user.
- b. Do not locate drinking fountains and trash receptacles immediately adjacent to each other.
- c. Locate drinking fountains in areas such as near building entries and intersections of two walkways.
- d. Do not locate drinking fountains where they will:
 - i. Impede pedestrian or vehicular circulation;
 - ii. Impede critical sight lines; or
 - iii. Where they would conflict with landscape maintenance equipment or emergency vehicle access.

FOUNTAINS/WATER FEATURES

5.8. If fountains are installed, conform with the following standards.

- a. Install fountain features with caution and forethought.
- b. Design fountains to address safety, be vandal-resistant, and be low-maintenance.
- c. Tile or plaster interiors of fountains, and recess fixtures in the wall or floor of the structure.
- d. Locate equipment in a recessed, locked vault.



Fountains can be amenities, but are often very expensive to build and maintain .

BOLLARDS

5.9. If bollards are installed, conform with the following standards.

- a. Use to control vehicular traffic or as pedestrian or bicycle control elements.
- b. Use removable bollards if emergency or service vehicles require access.

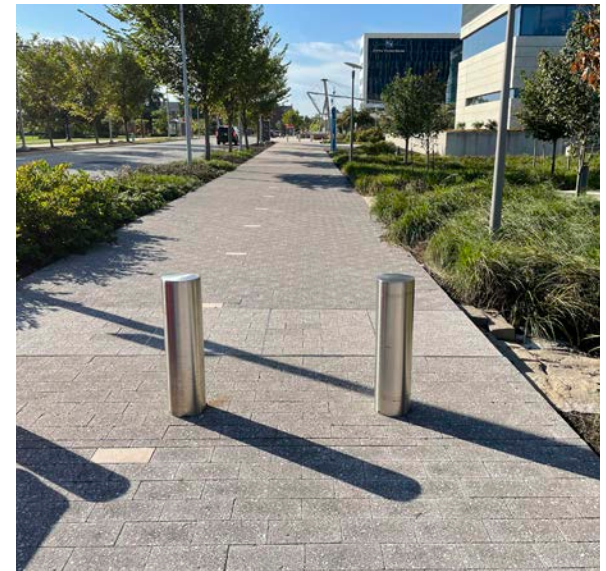

Bollards must be removable where emergency or service access is required.

TREE GRATES & GUARDS

5.10. Discourage the use of tree grates and guards.

5.11. If tree grates and guards are installed, conform with the following standards.

- a. Use only in areas of very high pedestrian traffic.
- b. Comply with ADA guidelines.
- c. Limit openings to no larger than ½-inch, but ¼-inch openings are preferable.
- d. Use tree grates that are as large as possible for the planting area. The minimum size for tree grates is 5 by 5 feet, unless the size used in "e" below is used.
- e. If possible, use rectangular tree grates of at least 48 by 96 inches.
- f. Use low "fence-style" tree guards (sometimes called border edging) where necessary to protect trees in areas of very high pedestrian traffic or in loading/service areas. Never use high "trunk-style" tree guards. The purpose of tree guards is to provide maximum coverage and protection around trees.



A "trunk-style" tree guard. Courtesy ARÉA.



"Fence-style" tree guards are appropriate in areas with very high pedestrian traffic.

6. LANDSCAPING

STREET TREES

6.1. Plant trees in the streetscape as follows.

- a. Provide tree spaces in at least a 4 feet by 10 feet planting area, the long dimension being parallel to the sidewalk.
- b. If tree spaces are enclosed, use one of the following methods:
 - i. Overlapping metal hoops:
 - ii. Posts with chains spanning between; or
 - iii. Raised granite or precast concrete curbs.

Flush curbs are permitted if installed in conjunction with either "i" or "ii."

Custom-designed guards may be considered subject to the approval of the City. All metal tree space guards must be at least 4 inches in height but not taller than 6 inches. All metal elements of the tree space guards must be painted black.

- c. Plant and maintain the entire street tree spaces with evergreen groundcover.

- d. Only plant seasonal plantings if they are sufficient quantity to grow in and cover the entire area of the tree space and are maintained in a healthy condition with an attractive appearance.
- e. Do not generally dig within tree spaces, to protect the roots of existing trees.
- f. Consider substitution of metal tree grates in heavy pedestrian traffic areas, subject to approval by the City.
- g. Select plant materials, particularly canopy trees, from varieties which are well adapted to the local climate and soils, resistant to pests and diseases, long-lived, and free of excessive litter and other maintenance problems.
- h. Attempt to preserve existing trees at or above 4 inches in caliper.

PARKING LOT TREES

6.2. Comply with citywide standards and the following.

- a. Maintain safety and visual access by specifying tree limbs at least 6 above grade and shrubs to between 3 and 6 feet above grade.
- b. Balance green planted space with paving in order to provide diversity, seasonal interest, and shade. Fewer large islands will sustain healthier trees than more numerous very small islands. Trees will have a greater impact than shrubs, which may be hidden behind cars.

SUSTAINABLE LANDSCAPING

Elements of sustainable landscape design are important, but other sustainable practices can only be incorporated at the level of community planning.

The appropriate use of vegetation in the built environment is a major influence on the quality of human life in a healthy environment. Plant materials filter pollutants in the air and water, mitigate wind and solar heat gain, stabilize soil to prevent

or reduce erosion, and provide an aesthetic counterpoint to the built environment. These attributes are essential to balancing the effects of humans on the land.

Furthermore, the native plant communities of a region provide some of the strongest cues to the unique identity of a place. Planting design should reflect the nature of the place, the requirements of maintenance and the general aesthetic of downtown.

The following guidelines will help ensure that the Central Creek District develops in an environmentally responsible way.

6.3. Plant native or adapted species as much as possible.

These plants will perform well in Goose Creek's climate, result in less irrigation need, and more resilient than exotic plantings.

See Plant Materials.

6.4. Use appropriate shrubs and groundcover.

If shrubs and groundcovers are used, reflect a design aesthetic that is commercial, not residential. Planting design will consist predominately of mass plantings of shrubs and groundcovers in arrangements that are simple in geometry and form, do not require significant maintenances, and are appropriate in scale for their specific context.

6.5. Encourage seasonal planting.

Seasonal plantings (annuals and perennials) are encouraged as they bring color to the downtown areas and show a higher level of care. The same principles of design that apply for shrubs and groundcovers apply for seasonal plantings.

6.6. Minimize lawns.

Lawn areas utilized in buffers and open space areas shall be used sparingly and groundcovers and mulched areas are preferred. However, where lawn areas are used, they shall be kept reasonably free of weeds and disease and shall be well maintained according to standard horticultural practices.

6.7. Reduce the need for irrigation

- a. Do not require irrigation in preserved trees, shrubs, and native plant communities, unless directed by the City.
- b. Drip irrigation systems shall be installed in areas planted with trees, shrubs, perennials, and groundcovers.
- c. Irrigate turfgrass areas on a different zone than trees, shrubs, perennials and ground covers.
- d. Use moisture sensor and/ or rain gauge equipment on automatic irrigation systems to

avoid irrigation during periods of sufficient rainfall.

- e. Do not allow significant irrigation overthrow onto impervious surfaces.
- f. Submit a watering schedule as part of the landscape plan. The schedule must indicate the different irrigation zones and the frequency and amount of irrigation.

The following are standard requirements of the Irrigation Plan:

- i. A detailed plan with the location of all irrigation components, i.e., controller, heads, back-flow preventer, valves, electrical lines, mainlines and secondary lines with their size and type.
- ii. Legend containing graphic symbols of the irrigation components.
- iii. Location of all existing and proposed structures and utilities, with the location of all sleeves, including sizes and types.

6.8. Ensure that landscaping is maintained.

Require property owners or their agents to maintain all landscapes. Some guidelines for landscape maintenance follow:

PLANT MATERIALS

Street & Parking Lot Trees

The following trees are all native to South Carolina and are suitable for most street trees and parking lots.

Crown Raising

Crown raising is restricted to less than 15% of the live crown height. Leave the crown at least two thirds of the total height of every tree. Only limbs 1/2" - 3".

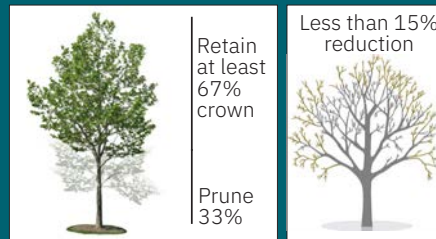

HIGHTOWER WILLOW OAK
Quercus phellos 'Hightower'

Recommended use: as a street tree due to its upright-oval form and proven urban adaptability and durability

Characteristics: likes full sun/part shade; tolerates air pollution; yellow fall color



LAUREL OAK
Quercus laurifolia

Recommended use: as a street or parking lot tree

Characteristics: tolerates air pollution; tolerates wet and poor soils



FLORIDA MAPLE
Acer floridanum

Recommended use: under power lines or where there are site constraints;

Characteristics: street tree with yellow and red fall color; tolerates air pollution



TRIDENT MAPLE
Acer buergerianum

Recommended use: under power lines or where there are site constraints;

Characteristics: street tree with yellow, orange and red fall color; tolerates air pollution



BALD CYPRESS
Taxodium distichum

Recommended use: street tree or parking lot (columnar version);

Characteristics: tolerates wet solids and inundation and air pollution; very few health problems; turns rusty gold in fall

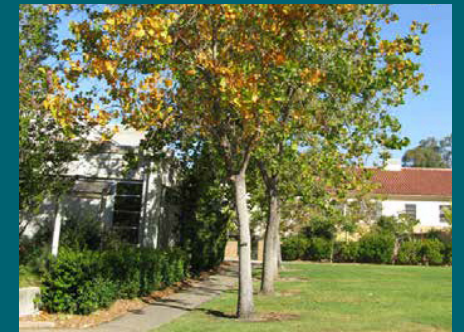

AMERICAN SYCAMORE
Platanus occidentalis

Recommended use: as a natural early colonizer of disturbed sites with yellow fall color; use in bioswales and rain gardens; use in medium-wet soils; tolerates air pollution

Flowering Trees

The following small flowering trees are native or adaptive to South Carolina and are suitable for street trees and parking lots with constrained conditions, such as overhead utilities.



LITTLE GEM DWARF SOUTHERN MAGNOLIA
Magnolia grandiflora 'Little Gem' (Native)
Recommended use: privacy screens; buffer strips around parking lots
Characteristics: evergreen with large white flowers during late spring to summer



SOUTHERN WAX MYRTLE
Myrica cerifera (Native)
Recommended use: privacy screens; buffer strips around parking lots
Characteristics: evergreen and fast growing with little to no pests or disease issues; handles wet soils; deer-resistant and provides bird habitat



LOBLOOLLY BAY
Gordonia lasianthus (Native)
Recommended use: privacy screens; buffer strips around parking lots; not ideal under powerlines
Characteristics: evergreen; handles wet soils; grows quickly



DOGWOOD
Cornus variety (var. *florida* = Native)
Recommended use: as a shrub border or backdrop species and can be used under powerlines; edge locations or buffer strips
Characteristics: attracts birds/butterflies; less than full-day sun; tolerates clay soils; showy flowers in April-May



SWEETBAY MAGNOLIA
Magnolia virginiana (Native)
Recommended use: as a specimen tree in wet soils; buffer strips around parking lots or for median strip plantings
Characteristics: tolerates clay and wet soils; tolerates air pollution; semi-evergreen with showy flowers in May-June



BOTTLEBRUSH
Callistemon citrinus
Recommended use: in wet soils; buffer strips around parking lots or for median strip plantings; constrained spaces
Characteristics: evergreen; tolerates sun or part shade; has bottlebrush shaped red blossoms in spring/summer



FRINGE TREE
Chionanthus virginicus (Native)
Recommended use: in front of a dark backdrop; as individual specimens or in groups as mixed shrub borders; under powerlines; constrained spaces; buffer strips around parking lots
Characteristics: attracts birds; prefers full sun/part shade; tolerates air pollution; showy flowers May-June

- a. Tree root zones may become compacted due to pedestrian and/or vehicular traffic. In this case, trees must be aerated at least once annually. Additionally, a deep root irrigator/feeder may be utilized to provide water, nutrients, and oxygen to other trees. Apply at the drip-line at least every 4 inches entering the ground 12 to 18 inches. It is recommended that this be done every two years.
- b. Trees generally require fertilization annually.
- c. Use 2 to 4 inches of organic material at least 4 feet in diameter around tree trunks. Add mulch as required but do not allow mulch to pile up around the trunk of tree.
- d. Prune to reduce foliage density, to remove dead or broken limbs, and to correct structural problems (crossed branching, etc.)
- e. Remove all staking and buying as soon as trees can support themselves. Timing varies by species and plant age; however, a general rule is twelve (12) months after planting.
- f. Most shrubs and groundcovers require supplemental feeding annually. The types of fertilizers as well as time of application vary. Base these decisions on standard horticultural practices.
- g. Mulch all shrub beds with 2 to 4 inches of organic material such as pine straw or shredded hardwood. Do not use bark chips. Add additional mulch as needed to maintain the desired depth.
- h. Prune shrubs only to remove dead or diseased branches or to improve shape and structure. Do not prune shrubs into unnatural geometric shapes. Hedges are labor intensive. Formal, clipped hedges should be kept to an absolute minimum. Avoid gouging and clipping hedges too closely as it is unsightly and harms the plant.
- i. Lawn areas may require aeration due to high pedestrian traffic. Do not fertilize new lawn areas until the area has been mown at least three times. This should allow an area sufficient time to become established prior to fertilization. Lawn areas should be mowed as required to maintain aesthetic appeal and vigor.

This page has been intentionally left blank

MATERIALS

6.9. Use the following materials for streetscape furniture, hardscape, site walls in public space, and signage.

The following materials are required as indicated. See Chapter 3: Buildings for the requirements for new buildings.

Material	Site Walls	Sidewalks / Walkways	Plazas / Patios	Other Locations
Wood				X
Concrete Pavers		X	X	X
Granite Fines / Slate Chips			X	X
Brick	X	X	X	X
Gray Concrete	X	X	X	X
Powder coated black metal				X
Corten Steel				X

X = Material is allowed on the indicated site element



Gray Concrete



Wood



Concrete Pavers

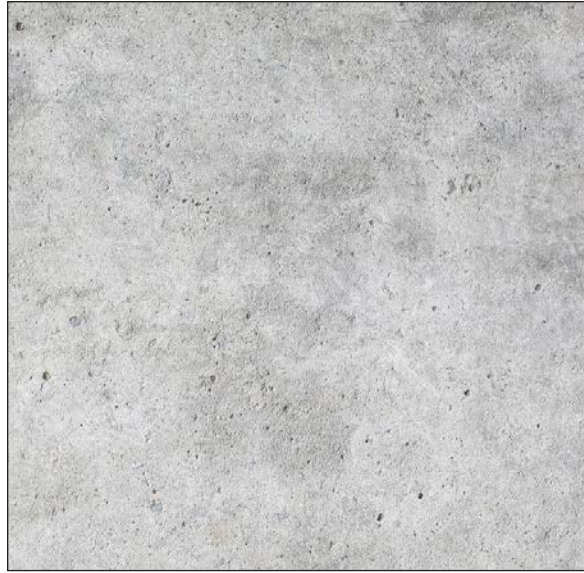

Gray Concrete



Granite Fines or Slate Chips

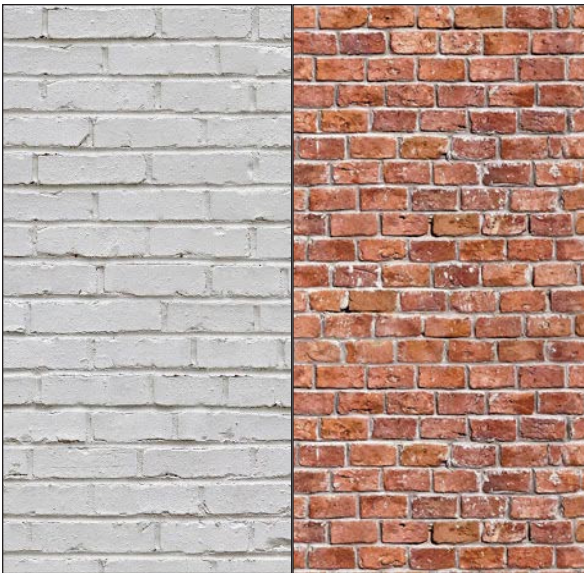

Brick

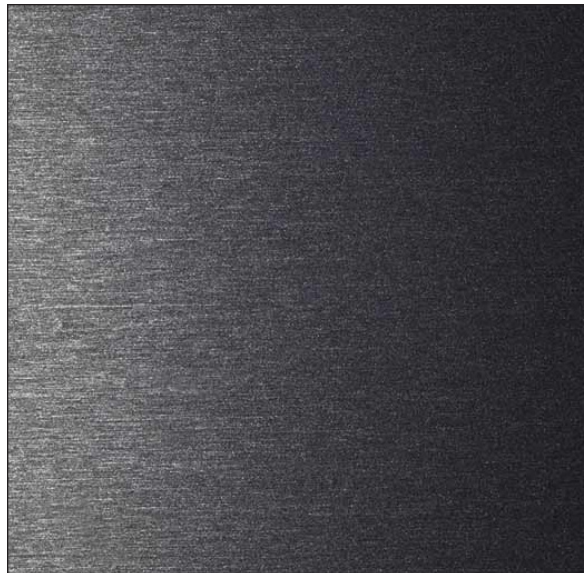

Powder coated black metal



Corten steel

