



**Architectural Review Board  
Monday, June 18, 2018  
6:30 p.m.**

**City of Goose Creek  
Marguerite H. Brown Municipal Center  
519 N. Goose Creek Blvd.  
Goose Creek, South Carolina**



## MEMORANDUM

---

**TO:** Members of the Architectural Review Board

**FROM:** Brenda Moneer  
Planning and Zoning Specialist

**DATE:** June 13, 2018

**SUBJECT:** Notification of ARB Meeting

This is to inform you that the Architectural Review Board (ARB) will meet Monday, June 18, 2018, 6:30 p.m. at City Hall. Enclosed please find agenda material for the meeting.

If you have any questions or comments, please don't hesitate to contact me at 797-6220 ext. 1116, or Kara at ext. 1118. We look forward to seeing you Monday evening.

**AGENDA  
CITY OF GOOSE CREEK  
ARCHITECTURAL REVIEW BOARD MEETING  
MONDAY, JUNE 18, 2018 6:30 P.M.  
MARGUERITE BROWN MUNICIPAL CENTER  
CITY HALL COUNCIL CHAMBERS  
519 N. GOOSE CREEK BLVD.**

- I.** Call to Order – Chairperson Sharon Clopton
- II.** Review of Minutes from May 21, 2018
- III. Old Business – Minor Applications - Signage**
  - A. Viper Auto Sales – 230 Red Bank Road – Monument
- IV. New Business – Minor Applications – Signage**
  - B. Ra Coffee – 110 S. Goose Creek Blvd. – Signage
  - C. Bi-Lo – 142E St. James Ave. – Signage Branding Upfit
  - D. Bi-Lo - 142E St. James Ave. – Exterior Paint/ReBrand
  - E. Active Day – 104 Springhall Dr. – Monument
  - F. Kidz Planet Pediatric Dentistry - 100 Hamlet Circle – Monument Sign
  - G. Metro North – 109 Central Ave. - Roof Color Change
  - H. Bank of America – 212 St. James Ave. – ATM replacement
- V.** Comments from Board
- VI.** Comments from Staff
- VII.** Adjournment

**VISION STATEMENT:**

Goose Creek is a city that has achieved a balance between growth, the environment, and the preservation of its small town character. The city's primary concern is for the lifelong needs of all its citizens. Goose Creek is a partnership between its government and its people in the determination of the city's future.

**MISSION STATEMENT:**

Objectively guide the evolution of commercial and industrial projects creating a synergy between the business and residential community consistent with the city of Goose Creek's vision statement.

**THE PROCEDURE FOR PARTICIPATION WILL BE AS FOLLOWS:**

Minor applications will be allotted three (3) minutes to present to the Board, major applications will be allotted five (5) minutes to present. Board members will be allowed to ask questions and to discuss merits of the application following the presentations. The question/discussion period by the Board will be limited to five (5) minutes for minor applications and ten (10) minutes for major applications.

*Please note this Agenda was posted at City Hall, the City Website, and notification was sent to local media 5 days prior to meeting.*

**MINUTES  
CITY OF GOOSE CREEK  
ARCHITECTURAL REVIEW BOARD MEETING  
MONDAY, MAY 21, 2018, 6:30 P.M.  
MARGUERITE H. BROWN MUNICIPAL CENTER  
519 N. GOOSE CREEK BOULEVARD**

**I. Call to Order – Chairperson, Sharon Clopton**

**Motion:** at 6:28 pm, **Action:** Called Meeting to Order, **Moved by** Sharon Clopton  
**Roll Call-**  
**Present:** Joel Arenson, Gary Becker, Lisa Burdick, David Cantrill, Sharon Clopton,  
Tom Risso  
**Absent:** Gary Becker  
**Staff Present:** Kara Browder, Brenda Moneer

**II. Review of Minutes from April 16, 2018**

**Motion:** Approve the minutes as presented., **Moved by** Joel Arenson,  
**Seconded by** Tom Risso.  
**Discussion:** There was none.  
**Vote:** All voted in favor.

**III. New Business – Minor Applications**

**A. Goose Creek Senior Living – Signage**

Mr. Greg Canterbury presented the application to the Board. He requested locating the sign 15' from back of curb.

**Motion:** Approve the application as submitted. **Moved by** Tom Risso, **Seconded by** Lisa Burdick.  
**Discussion:** Mr. Arenson inquired if this was just for the monument. Mr. Canterbury confirmed it was the only signage.  
**Vote:** All voted in favor.



## **B. Republic Finance – Signage**

The applicant presented the application to the Board. There was discussion about the condition of the façade of the building.

**Motion:** Approve the application as submitted. **Moved by** Tom Risso, **Seconded by** David Cantrill.  
**Discussion:** There was none.  
**Vote:** All voted in favor.

## **C. Stoners Pizza – Signage**

The applicant presented the application to the Board. There was discussion about replacing the signage with the new signage that is the same size.

**Motion:** Approve the application as submitted. **Moved by** Tom Risso, **Seconded by** Joel Arenson.  
**Discussion:** There was discussion about the red tenant panel.  
**Vote:** All voted in favor.

## **D. Walgreens – Branding Signage Upfit**

The applicant presented the application to the Board. He noted that this would not affect the sign sizes, only the new sign face.

**Motion:** Approve the application as submitted. **Moved by** Tom Risso, **Seconded by** Lisa Burdick.  
**Discussion:** There was none.  
**Vote:** All voted in favor.

## **E. Big T's – Canopy Signage**

The applicant presented the application to the Board. There was discussion about alternate designs using the logo only, and concern for the aesthetics of the proposal.

**Motion:** Deny the application as submitted, with the exception that the Big-T's logo could remain and the remaining text be omitted from the application. **Moved by** Tom Risso, **Seconded by** Joel Arenson.  
**Discussion:** There was none.  
**Vote:** All voted in favor.

#### **F. Big T's Liquor – Wall Mount Sign**

The applicant presented the application to the Board. There was discussion about this being a separate business from the convenience store and matching the raceway to the building.

**Motion:** Approve the application as submitted. **Moved by** Joel Arenson, **Seconded by** Tom Risso.  
**Discussion:** There was none.  
**Vote:** All voted in favor.

#### **G. Beltone Hearing Aid Center – Wall Mount Sign**

The applicant presented the application to the Board.

**Motion:** Approve the application as submitted. **Moved by** Tom Risso, **Seconded by** Lisa Burdick.  
**Discussion:** There was none.  
**Vote:** All voted in favor.

### **IV. New Business – Minor Applications – Signage and Exterior Modifications**

#### **H. Viper Auto Sales – Signage and Exterior Modifications**

Mr. Fernando Sampaio presented the exterior scope of work to the Board. There was discussion about the existing and proposed fence, and existing building color and proposal to include 6' of red around the bottom of the building. The Board stated confusion for the options as called out on the application. There was a brief discussion about the color of the garage doors. Mr. Risso stated concern for the aesthetics of the color as proposed. Mr. Cantrill inquired about the fencing. Mr. Sampaio stated he would add fencing around the lift and could paint or leave it treated wood.

**Motion:** Deny the application as submitted. **Moved by** Joel Arenson, **Seconded by** Tom Risso.  
**Discussion:** There was discussion regarding the fence, and the non-conforming sign as submitted exceeding the height restriction.  
**Vote:** All voted in favor.

## V. New Business – Major Applications

### I. 111 Lumber Lane – Exterior Modifications

Mr. John Bell presented the elevations, a color rendering, fencing, and site landscaping to the Board. They noted that the chain link would be replaced with incorporated slats, of a matt black vinyl. Mr. Bell explained the enclosures for the mechanical units. There was discussion about the modifications all the way around the building, landscaping and fencing.

**Motion:** Approve the application as submitted. **Moved by** Tom Risso, **Seconded by** David Cantrill.

**Discussion:** Ms. Burdick inquired about the landscaping.

**Vote:** All voted in favor.

### J. Dunbar – 105 Button Hall – Exterior Modifications

Mr. Brian Cain presented the elevations, photo's, with exterior mantraps proposed to the Board. Mr. Cain explained the purposed of the louvers for exhaust, and the mantraps. There was discussion about the mantrap chain link enclosures. He added the lighting above each lighting over the roll up doors and mantrap lighting above each door. Chairperson Clopton inquired if Staff had any concerns. Ms. Browder stated concerns for the mantraps and suggested to screen them as much as possible. Mr. Cain stated they could match the fencing with the building and provide low profile shrubbery. There was discussion about the mechanics of the door to the mantrap and access entry.

**Motion:** Approve the application as submitted with the addition that the chain link match the building with low level landscaping added around the mantraps. **Moved by** David Cantrill, **Seconded by** Joel Arenson.

**Discussion:** There was none.

**Vote:** All voted in favor.

### K. Ra Coffee – Exterior Modifications, Landscaping, Parking Lot

Mr. and Mrs. Guzman presented a power point to the Board outlining the plans to develop their business for Ra Coffee. There was a brief discussion about the signage coming at a future date. Ms. Burdick inquired about the roofing. The applicant stated that they would be adding a new roof.

**Motion:** Approve the application as submitted. **Moved by** Joel Arenson, **Seconded by** Tom Risso.

**Discussion:** There was none.

**Vote:** All voted in favor.

#### **L. Islamic Center – Exterior Modifications**

Staff noted that the signage information was not provided to Staff as requested for the Boards review. Mr. Ibrahim Azab stated what it would look like. Staff noted that the Board requires the proposal to be on paper, as previously requested prior to the meeting.

- Motion:** Deny the application due to lack of information. **Moved by** Joel Arenson **Seconded by** David Cantrill.
- Discussion:** Staff noted some of the details of the development of the project. The Board invited the applicant back with additional details to provide the vision for the project development.
- Vote:** All voted in favor. The application was denied.

#### **M. Wendy's – Parking Lot Modifications, Landscaping**

Mr. Danny Forsberg presented the parking lot modifications to the Board to alleviate the issue of egress for customers. He explained the need for an escape lane for drive thru, and the tall signage would be replaced with a monument type sign. There was discussion about the entrance/exit at the rear to provide additional egress.

- Motion:** Approve the application as submitted. **Moved by** Tom Risso, **Seconded by** Lisa Burdick.
- Discussion:** There was none.
- Vote:** All voted in favor.

#### **Added Discussion – Pumps at Time to Shine Car Wash**

Staff noted that per the Boards request a representative of Time to Shine was present to discuss the exposed pump area. Mr. Roper, owner of Time to Shine Car Wash, stated he was present to discuss a possible solution for the pumps. He mentioned he had hired a landscaper to plant plantings around the base of the vacuums to provide a natural screening. Mr. Roper presented photos to the Board of the type of plantings, noting the height at maturity. Chairperson Clopton Expressed concern for the size of the plantings. There was discussion about providing fencing and relocating the plantings around the fencing to provide screening. Mr. Roper stated he would do what the Board suggest. The Board suggested a three-sided fence, with a height to conceal the height of the pumps. The Board requested the fencing be a natural material and stained a color to match the building. Staff recommended that it match the building in materials and color and be treated such as requirements for a dumpster enclosure. Mr. Arenson inquired if the Board could see a sketch. Ms. Burdick suggested Staff approve the materials and colors. There was discussion about access to the pumps. Staff suggested the enclosure would have a swing door.

It was determined that Staff could meet with Mr. Roper to determine a final design to enclose the pumps.

**VI. Comments from the Board**

Mr. Cantrill inquired about the Big T's application. Staff noted the details of the application. There was discussion about the condition of the exterior of the building at 408 Red Bank Rd. Ms. Browder mentioned she had been working with the applicant on the modifications to the site. There was discussion regarding the improvements to that property. Mr. Arenson addressed the Board that he would be leaving the Board as he is relocating out of the City.

**VII. Comments from Staff**

Ms. Browder mentioned that she had set up a conference call about the Landscaping at All Star Storage.

**VIII. Adjournment**

- Motion:** Motion to adjourn at 8:02 pm., **Action:** Adjourn, **Moved by** Joel Arenson, **Seconded by** David Cantrill.
- Discussion:** There was none.
- Vote:** All voted in favor.

\_\_\_\_\_ Date \_\_\_\_\_  
Sharon Clopton, Chairperson

RECEIVED  
MAY 07 2018

OFFICE USE ONLY  
PERMIT #: 037627  
AMOUNT DUE: \$ 75.00  
DATE PAID: 5/7/18



BY: CITY OF GOOSE CREEK SIGN PERMIT APPLICATION

Today's Date: 04-30-18

1. Business Owner FERNANDO SAMPAIO Business Phone [Redacted]  
Name of Business VIPER AUTO SOLE Alternate Phone [Redacted]  
Street Address of Business 230 RED BANK RD / GOOSE CREEK, SC 29445  
Landlord/Lessor SAME Landlord's Phone [Redacted]  
Sign Company LAYOUT SIGNS Sign Co. Phone 843-408-0541  
Sign Co. Contact EDUARDO PUNTO Sign Co. Address 220 RED BANK RD UNIT 11

3. How many signs are you applying for? 1 How many signs does this business already have? 1

4. What kind of signs does this business already have? FREESTANDING SIGN  None

5. What type of business is applying for this sign permit:  
A. A stand alone business?  Yes  No  
B. A part of a shopping center?  Yes  No If yes, shopping center name: \_\_\_\_\_

6. What is the TMS number for this property? \_\_\_\_\_

7. What is the front setback of the business in feet? 58 FT (The distance from the front property line to the front of business)  
A. For corner lots only, what is the front setback for second street frontage in feet? \_\_\_\_\_

8. What is the width of the business in feet? 106 FT (The distance from wall to wall)  
A. For corner lots only, what is the width of the business for second street frontage in feet? \_\_\_\_\_

9. What is the property's road frontage in feet? \_\_\_\_\_ (This only applies to shopping centers erecting a freestanding sign)

10. Please attach photos showing:  
A. The storefront in relation to adjacent businesses;  
B. The specific location of proposed sign(s) on the property or building; and  
C. The actual sign if it already exists.

11. Please attach drawings of each proposed sign showing (drawn to scale):  
A. The completed sign as it will actually appear on the building  
B. All dimensions;  
C. Where the colors will appear;  
D. The location on the property (on a plat) of proposed & existing freestanding signs  
E. The location on the building of proposed & existing building signs

TYPE: FREESTANDING  
OFFICE USE ONLY  
MAX. NO. OF ALLOWED SIGNS: 1  
MAX ALLOWED SIGN AREA: 50 SF  
SIGN APPLICATION MEETS ORDINANCE

- 12. Please attach swatches, samples, and/or paint chips of all proposed colors to the application.
- 13. Please complete the Sign Information Table located on the following page.
- 14. You are required to attend the Architectural Review Board meeting in which your sign application is reviewed.
  - Please submit this application by the 1<sup>st</sup> Monday of the month for consideration that month by the ARB.
  - The ARB meets on the 3<sup>rd</sup> Monday of each month. (Please see attached ARB schedule for application deadlines and meetings.)

NOTE: Illuminated, exposed and non-exposed neon signs located on the interior of a business, which are visible from the exterior of the business, must be reviewed by the ARB. Such signs shall be included as part of a business's maximum allowable square footage of building signage, as authorized in Section 151.084 of the City Code. A "non-exposed neon sign" shall be interpreted as a neon sign that does not have externally visible neon tubing. Neon signs enclosed in plastic, glass and Plexiglas casings are considered "exposed neon signs." All electrical work must be in accordance with the City's Code of Ordinances and the National Electrical Code.

MAY 9 2018

BY: [Signature]

Note: This application contains multiple pages

**SIGN INFORMATION TABLE**

Required Information	Sign 1	Sign 2	Sign 3
Materials: (metal, plastic, wood, etc.)			
Illumination: Exterior, interior or not lighted			
Type of Sign:	Freestanding Sign		
Height (FEET)	5'		
Width (feet)	10'		
Area (square feet)	50		
All colors used on sign	RED		
Is there a graphic (picture) on the sign? (Y/N) If yes, size of graphic	NO		
Projection from building or cabinet width (thickness)	12"		
Number of styles of lettering	1		
Height of letters (if channel letters)	N/A		
If mounting individual letters, space between letters	N/A		
If mounting individual letters, space between words	N/A		
If window sign, size of window	N/A		
If changeable copy sign (reader board), number of lines	N/A		
If freestanding sign, distance between sign and street curb (ft)	21'		
If freestanding sign, total height above grade (ft)	10'		
If freestanding sign, landscaping materials to be planted at base of sign	Base Plantings w/ Planter Box	modified application ordinance	to meet requirements

Review the attached Zoning Ordinances pertaining to sign regulations (Section 151.084). Be advised to examine them thoroughly so as to avoid violations (Section 151.999):

By signing below, you certify the above information that you provided to be true and correct.

*[Handwritten Signature]*  
 \_\_\_\_\_  
 Signature of Applicant

04.30.18  
 \_\_\_\_\_  
 Date

Remarks: ARB denied 5/21/18. Resubmitted POB 6/18/18	OFFICE USE ONLY
Approval: Zoning Administrator _____ Issued by: _____ Date: _____	



# BEFORE



# FUTURE



5'

2'

3'

2'

 **VIPER**  
AUTO SALE  
REPAIR & BODY SHOP  
VIPERAUTOSALE.COM  
843-410-1887



**FREESTANDING SIGN**





RECEIVED JUN 04 2018

POSTED

OFFICE USE ONLY PERMIT #: 037764 AMOUNT DUE: \$ 75.00 DATE PAID: 6/4/18

CITY OF GOOSE CREEK SIGN PERMIT APPLICATION

Today's Date: 6/4/18 Permit Fee: \$75.00

1. Business Owner: CRISTINA + DAN GUZMAN Business Phone: Name of Business: RA Coffee Company LLC Alternate Phone: Street Address of Business: 110 S. Goose Creek Blvd. Landlord/Lessor: Landlord's Phone: Sign Company: Carolina Moon Signs + Graphics Sign Co. Phone: 843-779-7446 Sign Co. Contact: Hugh Welch Sign Co. Address: 107 St. James Ave Ste A2



3. How many signs are you applying for? 2 How many signs does this business already have? 1

4. What kind of signs does this business already have? Pylon [ ] None

5. What type of business is applying for this sign permit: A. A stand alone business? [x] Yes [ ] No B. A part of a shopping center? [ ] Yes [x] No If yes, shopping center name:

6. What is the TMS number for this property? 243-12-07-019

7. What is the front setback of the business in feet? 75' (The distance from the front property line to the front of business) A. For corner lots only, what is the front setback for second street frontage in feet?

8. What is the width of the business in feet? 50' (The distance from wall to wall) A. For corner lots only, what is the width of the business for second street frontage in feet?

9. What is the property's road frontage in feet? N/A (This only applies to shopping centers erecting a freestanding sign)

10. Please attach photos showing: A. The storefront in relation to adjacent businesses; B. The specific location of proposed sign(s) on the property or building; and C. The actual sign if it already exists.

11. Please attach drawings of each proposed sign showing (drawn to scale): A. The completed sign as it will actually appear on the building B. All dimensions; C. Where the colors will appear; D. The location on the property (on a plat) of proposed & existing freestanding signs E. The location on the building of proposed & existing building signs

OFFICE USE ONLY MAX. NO. OF ALLOWED SIGNS: Wall 50 SF Freestanding 50 SF MAX ALLOWED SIGN AREA:

Applying For: WALL: 16 SF FREESTANDING: 35 SF

12. Please attach swatches, samples, and/or paint chips of all proposed colors to the application.

13. Please complete the Sign Information Table located on the following page.

14. You are required to attend the Architectural Review Board meeting in which your sign application is reviewed. Please submit this application by the 1st Monday of the month for consideration that month by the ARB. The ARB meets on the 3rd Monday of each month. (Please see attached ARB schedule for application deadlines and meetings.)

NOTE: Illuminated, exposed and non-exposed neon signs located on the interior of a business, which are visible from the exterior of the business, must be reviewed by the ARB. Such signs shall be included as part of a business's maximum allowable square footage of building signage as authorized in Section 151.084 of the City Code. A "non-exposed neon sign" shall be interpreted as a neon sign that does not have externally visible neon tubing. Neon signs enclosed in plastic, glass and Plexiglas casings are considered "exposed neon signs." All electrical work must be in accordance with the City's Code of Ordinances and the National Electrical Code.

RECEIVED JUN 4 2018 BY: [Signature]

Note: This application contains multiple pages



**SIGN INFORMATION TABLE**

Required Information	Sign 1	Sign 2	Sign 3
Materials: (metal, plastic, wood, etc.)	Acrylic/Aluminum	Acrylic/Aluminum	
Illumination: Exterior, interior or not lighted	internal	internal	
Type of Sign:	Pylon	Wall	
Height (FEET)	5'	4'	
Width (feet)	7'	4'	
Area (square feet)	35 sq. ft. ✓	16 sq/ft ✓	
All colors used on sign	Burgundy/Black	Burgundy	
Is there a graphic (picture) on the sign? (Y/N) If yes, size of graphic	Yes 6'	Yes 3'6"	
Projection from building or cabinet width (thickness)	<del>10"</del> 10"	8"	
Number of styles of lettering	One	one	
Height of letters (if channel letters)	N/A	N/A	
If mounting individual letters, space between letters	N/A	N/A	
If mounting individual letters, space between words	N/A	N/A	
If window sign, size of window	N/A	N/A	
If changeable copy sign (reader board), number of lines	N/A	N/A	
If freestanding sign, distance between sign and street curb (ft)	25'	N/A	
If freestanding sign, total height above grade (ft) <b>Adjust to 10'</b>	12' <sup>face change</sup> (existing)	N/A	
If freestanding sign, landscaping materials to be planted at base of sign <b>see landscape plan</b>	Evergreen Shrubs	N/A	

Review the attached Zoning Ordinances pertaining to sign regulations (Section 151.084). Be advised to examine them thoroughly so as to avoid violations (Section 151.999):

By signing below, you certify the above information that you provided to be true and correct.

  
 \_\_\_\_\_  
 Signature of Applicant

6/21/18  
 \_\_\_\_\_  
 Date

OFFICE USE ONLY		
Remarks: _____		
Approval: Zoning Administrator _____ Issued by: _____ Date: _____		

# Exterior Landscaping A:



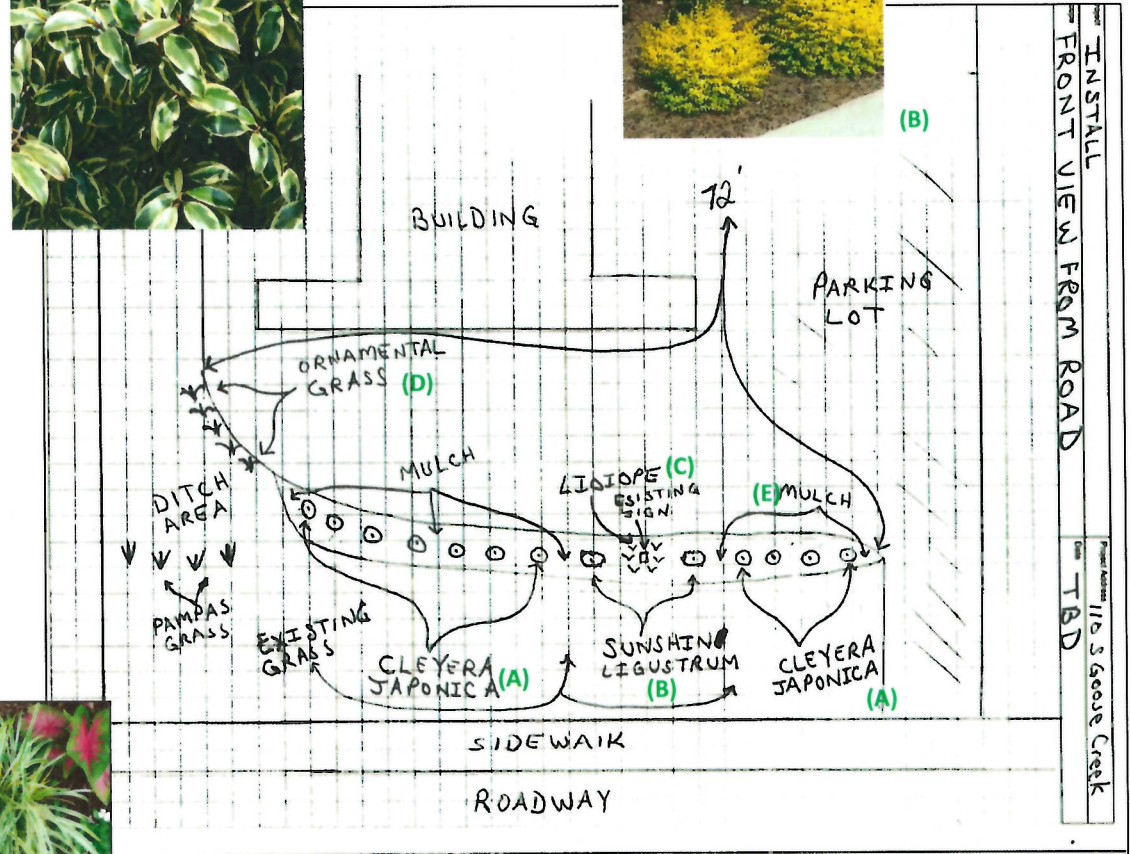
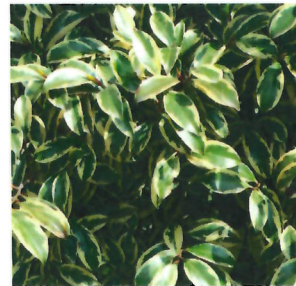

- Landscaping Proposal (Cedar Creek):
  - Removed all Juniper in front common area
  - Define/prep bedding for new plantings
  - Clean out retention ditch of all debris
  - Install Cleyera Japonica (5 foot in between each) (A)
  - Install Sunshine Ligustrum (one on left other on right of existing sign) (B)
  - Install Lidiope around sign pedestal (C)
  - Install Ornamental grasses in curved area of driveway (D)
  - Mulch area with a cypress wood (Red or brown bark) (E)
  - Trim and cleanup of shrubs and grass throughout property
  - Disperse an Organic granular fertilizer and post emergent for weeds to turf in common area. Turf is salvageable- new sod not required . \*



Cedar Creek Lawn Care  
 Business License # 04382  
 Goose Creek, SC 29445  
 843-708-9050 Barry  
 843-860-8180 Ken  
 AltNo.843-819-5985

Estimate No: 9225  
 Date: 5/1/2018  
 Job Location: 110 S Goose Creek Blvd  
 Goose Creek, SC 29445  
 Salesperson: BB

Dan and Christina Guzman  
 Goose Creek, SC 29445  
 805-914-4488

Code	Description	Qty	Hours	Rate	Amount
L.S	Scope of work per sketch. Removed all Juniper in front common area. Clean out retention ditch of all debris. Define prep bedding for new plantings. Install Cleyera Japonica (5 foot in between each), Sunshine Ligustrum (one on left other on right of existing sign), Lidiope around Sign. Ornamental grasses in curved area. Mulch area with a cypress wood (color choices Black, Red, Brown and Natural). Will disperse an Organic granular fertilizer and post emergent for weeds to turf in common area. There is no need to sod area with new turf. Turf in is salvageable. *				
					
					



# Exterior Signage:

- 1 Circular Led Sign 4' on Front of Building
- Qty 2 Replacement Panels for Existing Pedestal Sign Display
- Signs to be Completed by Hugh Welch, Carolina Sign Co.



4'x4'





POSTED

OFFICE USE ONLY
PERMIT #: 037750
AMOUNT DUE: \$ 75.00
DATE PAID: 5/31/2018

CITY OF GOOSE CREEK SIGN PERMIT APPLICATION

Today's Date: 5/31/18

Permit Fee: \$75.00

1. Business Owner B-I-L-O Business Phone

Name of Business B-I-L-O Alternate Phone

Street Address of Business 142E. St. James Ave Goose Creek SC 29445

Landlord/Lessor Landlord's Phone

Sign Company Palmetto State Sign Installation Sign Co. Phone TTS 233.6580

Sign Co. Contact Maria Whack Sign Co. Address 131 Eare Ln Goose Creek SC 29445

Removal BL # pd 10061

3. How many signs are you applying for? 3 How many signs does this business already have? 1 If will be replaced.

4. What kind of signs does this business already have? B-I-L-O None

5. What type of business is applying for this sign permit:
A. A stand alone business? Yes No
B. A part of a shopping center? X Yes No If yes, shopping center name: Berkeley Square

6. What is the TMS number for this property?

7. What is the front setback of the business in feet? 340 ft (The distance from the front property line to the front of business) 340 ft

A. For corner lots only, what is the front setback for second street frontage in feet?

8. What is the width of the business in feet? 280 ft (The distance from wall to wall)

A. For corner lots only, what is the width of the business for second street frontage in feet?

9. What is the property's road frontage in feet? (This only applies to shopping centers erecting a freestanding sign)

10. Please attach photos showing:

- A. The storefront in relation to adjacent businesses;
B. The specific location of proposed sign(s) on the property or building; and
C. The actual sign if it already exists.

wall mount
OFFICE USE ONLY
MAX. NO. OF ALLOWED SIGNS: 3
MAX ALLOWED SIGN AREA: 300 sq ft

11. Please attach drawings of each proposed sign showing (drawn to scale):

- A. The completed sign as it will actually appear on the building
B. All dimensions;
C. Where the colors will appear;
D. The location on the property (on a plat) of proposed & existing freestanding signs
E. The location on the building of proposed & existing building signs

applied for 2 calc. @ 146.9 ft

12. Please attach swatches, samples, and/or paint chips of all proposed colors to the application.

13. Please complete the Sign Information Table located on the following page.

14. You are required to attend the Architectural Review Board meeting in which your sign application is reviewed.

- Please submit this application by the 1st Monday of the month for consideration that month by the ARB.
The ARB meets on the 3rd Monday of each month. (Please see attached ARB schedule for application deadlines and meetings.)

NOTE: Illuminated, exposed and non-exposed neon signs located on the interior of a business, which are visible from the exterior of the business, must be reviewed by the ARB. Such signs shall be included as part of a business's maximum allowable square footage of building signage, as authorized in Section 151.084 of the City Code. A "non-exposed neon sign" shall be interpreted as a neon sign that does not have externally visible neon tubing. Neon signs enclosed in plastic, glass and Plexiglas casings are considered "exposed neon signs." All electrical work must be in accordance with the City's Code of Ordinances and the National Electrical Code.

JUN 4 2018

Note: This application contains multiple pages

BY: Bloncer

**SIGN INFORMATION TABLE**

Required Information	Sign 1 <i>Bi-W</i>	Sign 2 <i>Pharmacy</i>	tenant panel Sign 3 ✓ <i>Bi-to - face change</i>
Materials: (metal, plastic, wood, etc.)	<i>Aluminum, <del>metal</del>, Vinyl</i>	<i>Aluminum</i>	<i>Polycarbonate</i>
Illumination: Exterior, interior or not lighted	<i>LED</i>	<i>LED</i>	
Type of Sign:	<i>Wall</i>	<i>Wall</i>	<i>tenant panel</i>
Height (FEET)	<i>6'</i>	<i>1' 6"</i>	<i>4</i>
Width (feet)	<i>24' 11"</i>	<i>11' 6 1/16"</i>	<i>8' 1"</i>
Area (square feet)	<i>148.92</i>	<i>17.3</i>	<i>32.3</i>
All colors used on sign	<i>Green, White, Black</i>	<i>Green, White, Black</i>	<i>Green, White, Black</i>
Is there a graphic (picture) on the sign? (Y/N) If yes, size of graphic	<i>No</i>	<i>No</i>	<i>No</i>
Projection from building or cabinet width (thickness)	<i>5"</i>	<i>5"</i>	
Number of styles of lettering	<i>1</i>	<i>1</i>	<i>1</i>
Height of letters (if channel letters)	<i>6'</i>	<i>1' 6"</i>	
If mounting individual letters, space between letters			
If mounting individual letters, space between words			
If window sign, size of window			
If changeable copy sign (reader board), number of lines			
If freestanding sign, distance between sign and street curb (ft)			
If freestanding sign, total height above grade (ft)			
If freestanding sign, landscaping materials to be planted at base of sign			

Review the attached Zoning Ordinances pertaining to sign regulations (Section 151.084). Be advised to examine them thoroughly so as to avoid violations (Section 151.999):

By signing below, you certify the above information that you provided to be true and correct.

*[Signature]*  
Signature of Applicant

*5/31/18*  
Date

<u>OFFICE USE ONLY</u>		
Remarks: _____		
Approval: Zoning Administrator _____ Issued by: _____ Date: _____		



166.9#

2018



**Site Brand Book**

BILO #5246  
142 East St. James Ave.  
Goose Creek, SC 29445

**QID#** 18-41860

**Designer:**  
Greg Sloan

**Date:**  
5-16-18



- A** 6'-0" BI-LO CHANNEL LETTERS
- B** 1'-6" PHARMACY CHANNEL LETTERS

Approved By: \_\_\_\_\_ Date: \_\_\_\_\_

Opening Date: \_\_\_\_\_

Install Date: \_\_\_\_\_

280' width



**PROPOSED SIGNAGE: FRONT ELEVATION**

Allowable Square Footage: 300.0  
 Proposed Square Feet: 166.2  
 Square Feet Remaining After Proposed: 133.8

SIGN	SIZE	SQ. FT.
BI-LO	6'-0"	148.92
+ Pharmacy	1'-6"	17.3

**HILTON DISPLAYS**  
 125 HILLSIDE DRIVE - GREENVILLE SC 29607  
 P 800 353 9132 - F 864 242 2204  
 www.hiltondisplays.com

**QID 18-41860**

JOB NAME

BILO #5246

LOCATION

142 East James Ave.  
 Goose Creek, SC 29445

CUSTOMER CONTACT

SALESMAN / PM

Ray Garron

DESIGNER

Greg Sloan

DWG. DATE

5-16-18

REV. DATE / REVISION

SCALE

FILE

2018/BI LO/  
 Goose Creek SC/18-41860/  
 BILO Goose Creek SC 5246

DESIGN SPECIFICATIONS ACCEPTED BY:

EST: CLIENT:

SLS PM: LANDLORD:

THE INTENT OF THIS DRAWING IS TO SHOW A CONCEPTUAL REPRESENTATION OF THE PROPOSED SIGNAGE. DUE TO VARIATIONS IN PRINTING DEVICES AND SUBSTRATES, THE FINISHED PRODUCT MAY DIFFER SLIGHTLY FROM DRAWING.

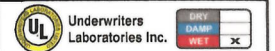

- "BI-LO" INSTALLATION NOTES:**
1. GREEN VINYL APPLIED FIRST SURFACE TO EXISTING GLASS
  2. "BI-LO" LETTERS TO UTILIZE EXISTING MOUNTING ANGLES

**ILLUMINATED CHANNEL LETTERS**

**BIL0-72-RCL-W-PRISM**

Qty. 1

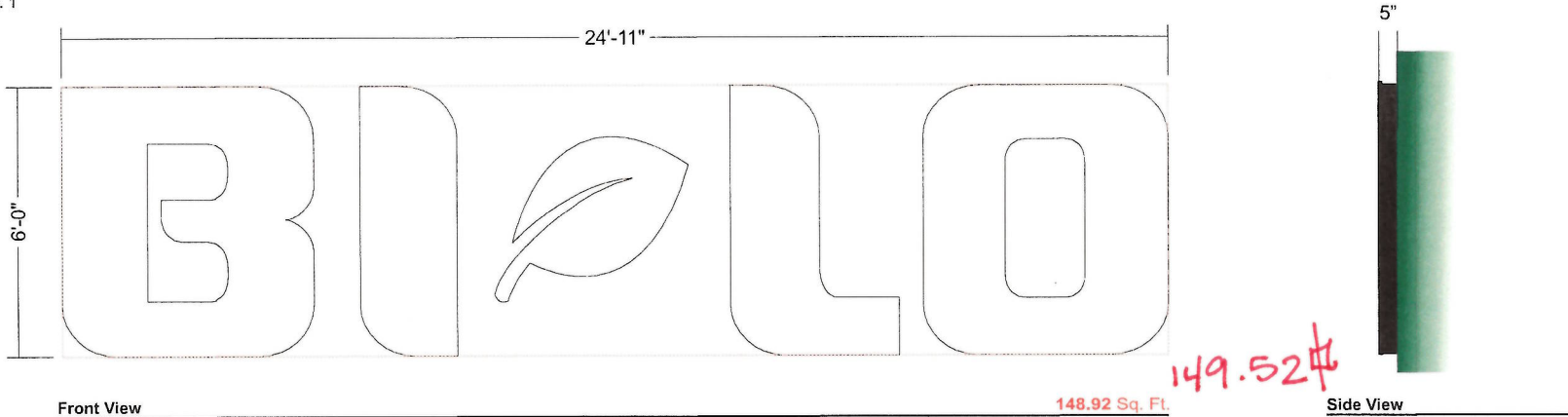

**Front View**

Scale: 3/8" = 1'-0" ( 11 x 17 )

149.52 sq. Ft.

**Side View**

Scale: 3/8" = 1'-0" ( 11 x 17 )

- A. .040" X 5" PRE-FINISHED BLACK ALUMINUM RETURNS
- B. 1" GLOSS BLACK JEWELITE
- C. .063" ALUMINUM BACKS
- D. COPY: .150" WHITE PCB FACES  
LEAF: .150" WHITE PCB FACES
- E. WHITE SLOAN PRISM 7100K LEDS
- F. POWER CABLE STARTING FROM POWER SUPPLY THEN LETTER TO LETTER (BEHIND FASCIA)
- G. 1/4" WEEP HOLES AS REQUIRED (FOR EXTERIOR INSTALLATION ONLY)

- H. SILICONE BEAD AROUND THE INSIDE OF RETURN AND BACK TO SEAL FROM WATER LEAKAGE
- I. 3/8" THREADED RODS WITH 2" x 4" WOOD BLOCKING AS REQ'D
- J. 3/8" RIV NUTS
- K. 1/2" SEALTITE CONDUIT RUNNING TO SECONDARY CONNECTION
- \* NOTE: GENERAL CONTRACTOR TO HAVE PRIMARY CONNECTION HOOKED UP
- L. STANDARD POWER SUPPLY HOUSED IN A WEATHERPROOF SHEET METAL BOX

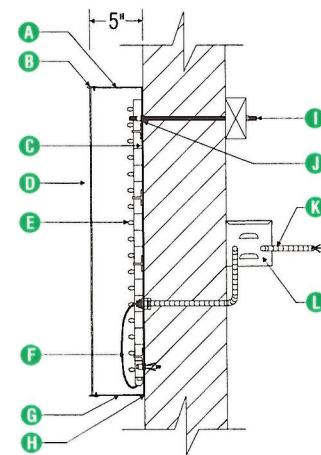

**TYPICAL WALL SECTION:**  
NOT TO SCALE

**HILTONDISPLAYS**

125 HILLSIDE DRIVE • GREENVILLE SC 29607  
P 800 353 9132 • F 864 242 2204  
www.hiltondisplays.com

**QID 18-41860**

**JOB NAME**

**BILO #5246**

**LOCATION**

**142 East James Ave.  
Goose Creek, SC 29445**

**CUSTOMER CONTACT**

**SALESMAN / PM**

**Ray Garron**

**DESIGNER**

**Greg Sloan**

**DWG. DATE**

**5-16-18**

**REV. DATE / REVISION**

**SCALE**

**FILE**

**2018/BI LO/  
Goose Creek SC/18-41860/  
BILO Goose Creek SC 5246**

**DESIGN SPECIFICATIONS ACCEPTED BY:**

EST: CLIENT:

SLS PM: LANDLORD:

THE INTENT OF THIS DRAWING IS TO SHOW A CONCEPTUAL REPRESENTATION OF THE PROPOSED SIGNAGE. DUE TO VARIATIONS IN PRINTING DEVICES AND SUBSTRATES, THE FINISHED PRODUCT MAY DIFFER SLIGHTLY FROM DRAWING.

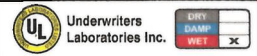



**VINYL GRAPHICS PANEL(S)**

18-41860-2  
QTY. 52

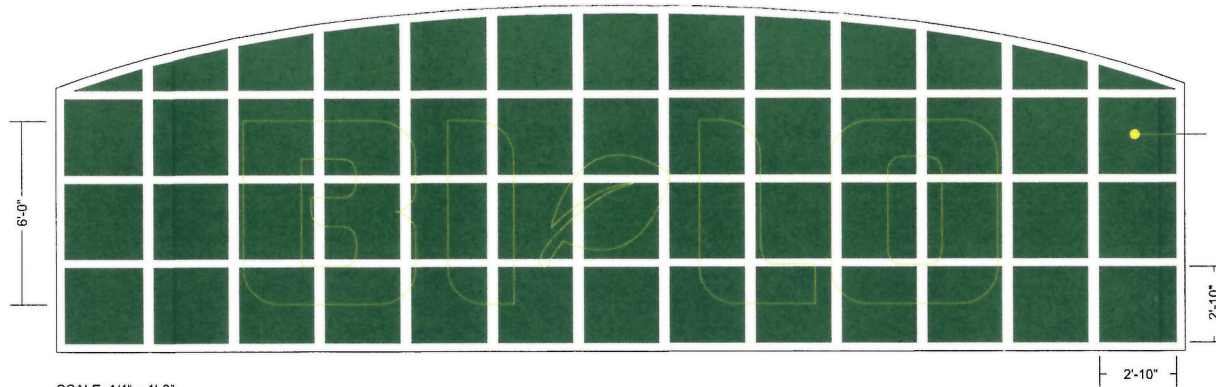

CUT VINYL GRAPHICS:  
52 QTY. @ 2'-10" X 2'-10"  
3M 3630-76 HOLLY GREEN

SCALE: 1/4" = 1'-0"

- A. 3M 3630-76 HOLLY GREEN VINYL APPLIED TO FIRST SURFACE OF EXISTING GLASS INSIDE OF MULLIONS AS SHOWN
- B. CUT VINYL GRAPHICS:  
52 QTY. @ 2'-10" X 2'-10"
- C. "BI-LO" CHANNEL LETTERS INSTALLED ON EXISTING MOUNTING ANGLES

**NOTE:** INDIVIDUAL VINYL GRAPHICS PANELS ARE OVSIZED AS RECOMMENDED FOR EASE OF INSTALLATION, AND WILL REQUIRE TRIMMING TO SIZE AFTER INSTALLATION IS COMPLETE

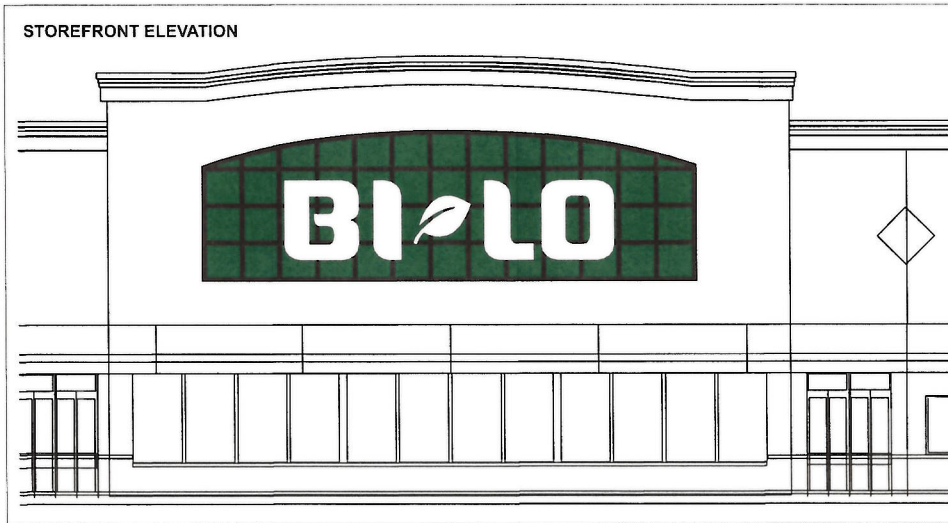

COLOR LEGEND	
PMS/PAIN	VINYL
PMS 357 C	3M 3630-76

**HILTONDISPLAYS**  
125 HILLSIDE DRIVE • GREENVILLE SC 29607  
P 800 353 9132 • F 864 242 2204  
www.hiltondisplays.com

**QID 18-41860**

JOB NAME

BILO #5246

LOCATION

142 East James Ave.  
Goose Creek, SC 29445

CUSTOMER CONTACT

SALESMAN / PM

Ray Garron

DESIGNER

Greg Sloan

DWG. DATE

5-16-18

REV. DATE / REVISION

SCALE

FILE

2018/BI LO/  
Goose Creek SC/18-41860/  
BILO Goose Creek SC 5246

DESIGN SPECIFICATIONS ACCEPTED BY:

EST: CLIENT:

SLS/PM: LANDLORD:

THE INTENT OF THIS DRAWING IS TO SHOW A CONCEPTUAL REPRESENTATION OF THE PROPOSED SIGNAGE. DUE TO VARIATIONS IN PRINTING DEVICES AND SUBSTRATES, THE FINISHED PRODUCT MAY DIFFER SLIGHTLY FROM DRAWING.

Underwriters Laboratories Inc.

DRY DAMP WET

**ILLUMINATED CHANNEL LETTERS**

**BILO-18I-PHARM-RCL-W-PRISM**

Qty. 1

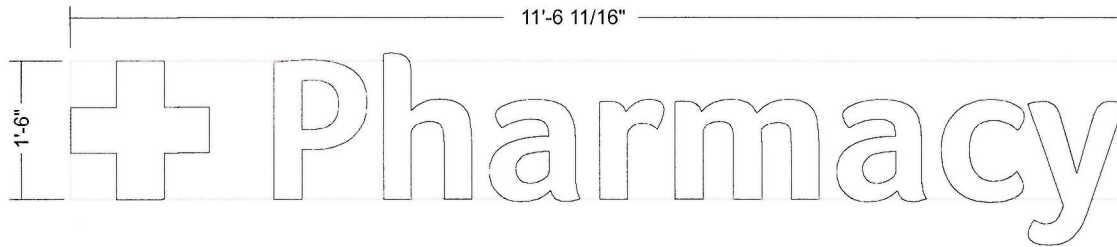

**Front View**

Scale: 3/4" = 1'-0" ( 11 X 17 )

17.38 Sq. Ft.

17.38 #



**Side View**

Scale: 1/2" = 1'-0" ( 11 X 17 )

- A. .040" X 5" PRE-FINISHED BLACK ALUMINUM RETURNS
- B. 1" GLOSS BLACK JEWELITE
- C. .063" ALUMINUM BACKS
- D. .150" WHITE PCB FACES
- E. WHITE SLOAN PRISM 7100K LEDs
- F. POWER CABLE STARTING FROM POWER SUPPLY THEN LETTER TO LETTER (BEHIND FASCIA)
- G. 1/4" WEEP HOLES AS REQUIRED (FOR EXTERIOR INSTALLATION ONLY)

- H. SILICONE BEAD AROUND THE INSIDE OF RETURN AND BACK TO SEAL FROM WATER LEAKAGE
- I. 3/8" THREADED RODS WITH 2" X 4" WOOD BLOCKING AS REQ'D
- J. 3/8" RIV NUTS
- K. 1/2" SEALTITE CONDUIT RUNNING TO SECONDARY CONNECTION  
\* NOTE: GENERAL CONTRACTOR TO HAVE PRIMARY CONNECTION HOOKED UP
- L. STANDARD POWER SUPPLY HOUSED IN A WEATHERPROOF SHEET METAL BOX

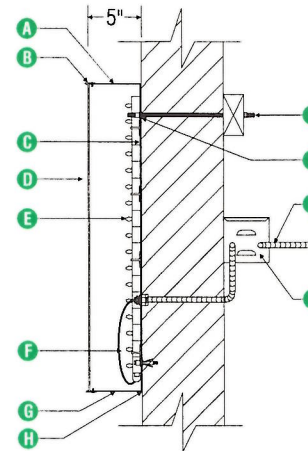

**TYPICAL WALL SECTION:**  
NOT TO SCALE

**HILTON DISPLAYS**  
125 HILLSIDE DRIVE • GREENVILLE SC 29607  
P 800 353 9132 • F 864 242 2204  
www.hiltondisplays.com

**QID 18-41860**

JOB NAME

BILO #5246

LOCATION

142 East James Ave.  
Goose Creek, SC 29445

CUSTOMER CONTACT

SALESMAN / PM

Ray Garron

DESIGNER

Greg Sloan

DWG. DATE

5-16-18

REV. DATE / REVISION

SCALE

FILE

2018/BI LO/  
Goose Creek SC/18-41860/  
BILO Goose Creek SC 5246

DESIGN SPECIFICATIONS ACCEPTED BY:

EST: CLIENT:

SLS/PM: LANDLORD:

THE INTENT OF THIS DRAWING IS TO SHOW A CONCEPTUAL REPRESENTATION OF THE PROPOSED SIGNAGE. DUE TO VARIATIONS IN PRINTING DEVICES AND SUBSTRATES, THE FINISHED PRODUCT MAY DIFFER SLIGHTLY FROM DRAWING.

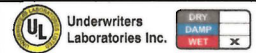



**PYLON - PAN-FORMED REPLACEMENT FACES**

**18-41860-5**

Qty. 2 EACH



**FRONT VIEW**  
SCALE: 3/4" = 1'-0"

- A. PAN-FORMED 3/16" WHITE POLYCARBONATE REPLACEMENT FACES WITH FIRST SURFACE 3M 3630-76 HOLLY GREEN VINYL REVERSE CUT TO REVEAL WHITE "BI-LO" LETTERS
- B. 2" EXISTING RETAINERS

COLOR LEGEND	
PMS/PAIN	VINYL
PMS 357C	3M 3630-76
PMS WHITE	



BEFORE



AFTER



**HILTON DISPLAYS**  
125 HILLSIDE DRIVE • GREENVILLE SC 29607  
P 800 353 9132 • F 864 242 2204  
www.hiltondisplays.com

**QID 18-41860**

JOB NAME

**BILO #5246**

LOCATION

**142 East James Ave.  
Goose Creek, SC 29445**

CUSTOMER CONTACT

SALESMAN / PM

**Ray Garron**

DESIGNER

**Greg Sloan**

DWG. DATE

**5-16-18**

REV. DATE / REVISION

SCALE

FILE

**2018/BI LO/  
Goose Creek SC/18-41860/  
BILO Goose Creek SC 5246**

DESIGN SPECIFICATIONS ACCEPTED BY:

EST: CLIENT:

SLS/PM: LANDLORD:

THE INTENT OF THIS DRAWING IS TO SHOW A CONCEPTUAL REPRESENTATION OF THE PROPOSED SIGNAGE. DUE TO VARIATIONS IN PRINTING DEVICES AND SUBSTRATES, THE FINISHED PRODUCT MAY DIFFER SLIGHTLY FROM DRAWING.

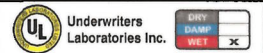



## ARCHITECTURAL REVIEW BOARD: SCOPE OF WORK

**PROJECT:** Bi-Lo

**LOCATION:** 142 St James Ave., Unit E

The applicant will be presenting elevations showing the re-painting with the new branding colors.





CITY OF GOOSE CREEK SIGN PERMIT APPLICATION

OFFICE USE ONLY
PERMIT #: 037785
AMOUNT DUE: \$ 75.00
DATE PAID: 6-6-18

Today's Date: 5/30/2018 Permit Fee: \$75.00
1. Business Owner Business Phone
Name of Business Active Day Alternate Phone
Street Address of Business 104 Springhall Dr.
Landlord/Lessor Landlord's Phone
Sign Company 321 Graphics Group Sign Co. Phone 803-581-5968



- 3. How many signs are you applying for? 1 How many signs does this business already have? 1
4. What kind of signs does this business already have? Monument (No Lit)
5. What type of business is applying for this sign permit:
A. A stand alone business? Yes No
B. A part of a shopping center? Yes No
6. What is the TMS number for this property?
7. What is the front setback of the business in feet?
8. What is the width of the business in feet?
9. What is the property's road frontage in feet?
10. Please attach photos showing:
11. Please attach drawings of each proposed sign showing (drawn to scale):
12. Please attach swatches, samples, and/or paint chips of all proposed colors to the application.
13. Please complete the Sign Information Table located on the following page.
14. You are required to attend the Architectural Review Board meeting in which your sign application is reviewed.

OFFICE USE ONLY
MONUMENT 1
MAX. NO. OF ALLOWED SIGNS: 1
MAX ALLOWED SIGN AREA: 50

applying for 1 sign @ 18.85#

NOTE: Illuminated, exposed and non-exposed neon signs located on the interior of a business, which are visible from the exterior of the business, must be reviewed by the ARB. Such signs shall be included as part of a business's maximum allowable square footage of building signage, as authorized in Section 151.084 of the City Code.

Note: This application contains multiple pages

**SIGN INFORMATION TABLE**

Required Information	Sign 1	Sign 2	Sign 3
Materials: (metal, plastic, wood, etc.)	HUD		
Illumination: Exterior, interior or not lighted	Exterior		
Type of Sign:	Sand blasted		
Height (FEET)	3.25		
Width (feet)	5.79		
Area (square feet)	18.82		
All colors used on sign	Blue 3 shades of yellow		
Is there a graphic (picture) on the sign? (Y/N) If yes, size of graphic	Yes		
Projection from building or cabinet width (thickness)			
Number of styles of lettering	1		
Height of letters (if channel letters)			
If mounting individual letters, space between letters			
If mounting individual letters, space between words			
If window sign, size of window			
If changeable copy sign (reader board), number of lines			
If freestanding sign, distance between sign and street curb (ft)			
If freestanding sign, total height above grade (ft)			
If freestanding sign, landscaping materials to be planted at base of sign			

Review the attached Zoning Ordinances pertaining to sign regulations (Section 151.084). Be advised to examine them thoroughly so as to avoid violations (Section 151.999):

By signing below, you certify the above information that you provided to be true and correct.

\_\_\_\_\_ Date

Signature of Applicant

<u>OFFICE USE ONLY</u>		
Remarks: _____		
_____		
Approval: Zoning Administrator	Issued by:	Date:



Single sided sandblasted HUD face mount on existing sign

HUD panel background painted a Cool Gray 2 C pantone color

Raised Painted letters



104 Springhall Dr,  
Goose Creek, SC 29445



GROUP.COM

**GRAPHICS**  
DESIGN • SIGNS • WRAPS • WEB  
 2787 DOUGLAS SCHOOL RD.  
 CHESTER, SC 29706  
 803-581-5968 PHONE  
 803-385-7474 CELL  
 803-581-6007 FAX

**Project:**

**Client:**

Active Day

**Contact:**

**Install Location:**

104 Springhall Dr,  
Goose Creek, SC 29445

**Install Date:**

TBD

**Install Notes:**

- Conceptual
- Final Production

**Approved By:**

**Page:**

1 of 2



RECEIVED JUN 04 2018

OFFICE USE ONLY PERMIT #: 035685 AMOUNT DUE: \$ DATE PAID: 5/17/17

BY: [Signature]

CITY OF GOOSE CREEK SIGN PERMIT APPLICATION

Today's Date: 4-June-2018

Permit Fee: \$75.00

1. Business Owner Matthew Swasty Business Phone [Redacted] Name of Business Kidz Planet Pediatric Dentistry Alternate Phone [Redacted] Street Address of Business 100 Hamlet Cir goose creek Landlord/Lessor N/A Landlord's Phone N/A Sign Company Owner making Sign Co. Phone N/A Sign Co. Contact Sign Co. Address [Redacted]

3. How many signs are you applying for? 1 How many signs does this business already have? 0

4. What kind of signs does this business already have? removing existing signs from prior property owner [X] None

5. What type of business is applying for this sign permit: A. A stand alone business? [X] Yes [ ] No B. A part of a shopping center? [ ] Yes [X] No If yes, shopping center name: \_\_\_\_\_

6. What is the TMS number for this property? 234 - 00 - 00 - 060

7. What is the front setback of the business in feet? 80 (The distance from the front property line to the front of business) A. For corner lots only, what is the front setback for second street frontage in feet? \_\_\_\_\_

8. What is the width of the business in feet? 75 (The distance from wall to wall) A. For corner lots only, what is the width of the business for second street frontage in feet? \_\_\_\_\_

9. What is the property's road frontage in feet? 250 (This only applies to shopping centers erecting a freestanding sign)

10. Please attach photos showing: A. The storefront in relation to adjacent businesses; B. The specific location of proposed sign(s) on the property or building; and C. The actual sign if it already exists.

OFFICE USE ONLY MAX. NO. OF ALLOWED SIGNS: 1 FREE-SIGNAGE MAX ALLOWED SIGN AREA: 500SF

11. Please attach drawings of each proposed sign showing (drawn to scale): A. The completed sign as it will actually appear on the building B. All dimensions; C. Where the colors will appear; D. The location on the property (on a plat) of proposed & existing freestanding signs E. The location on the building of proposed & existing building signs

12. Please attach swatches, samples, and/or paint chips of all proposed colors to the application.

13. Please complete the Sign Information Table located on the following page.

14. You are required to attend the Architectural Review Board meeting in which your sign application is reviewed. • Please submit this application by the 1st Monday of the month for consideration that month by the ARB. • The ARB meets on the 3rd Monday of each month. (Please see attached ARB schedule for application deadlines and meetings.)

NOTE: Illuminated, exposed and non-exposed neon signs located on the interior of a business, which are visible from the exterior of the business, must be reviewed by the ARB. Such signs shall be included as part of a business's maximum allowable square footage of building signage, as authorized in Section 151.084 of the City Code. A "non-exposed neon sign" shall be interpreted as a neon sign that does not have externally visible neon tubing. Neon signs enclosed in plastic, glass and Plexiglas casings are considered "exposed neon signs." All electrical work must be in accordance with the City's Code of Ordinances and the National Electrical Code.

RECEIVED JUN 4 2018 BY: [Signature]

Note: This application contains multiple pages

**SIGN INFORMATION TABLE**

Required Information	Sign 1	Sign 2	Sign 3
Materials: (metal, plastic, wood, etc.)	Brick Monument Base		
Illumination: Exterior, interior or not lighted	Existing Lights from prior owners sign		
Type of Sign:	Monument		
Height (FEET)	8' 6"		
Width (feet)	7'		
Area (square feet)	46 sq/ft x 2 Faces		
All colors used on sign	Black/Silver/White letters	Blue planet	
Is there a graphic (picture) on the sign? (Y/N) If yes, size of graphic	N		
Projection from building or cabinet width (thickness)	Letters will stand off Brick Face		
Number of styles of lettering	2		
Height of letters (if channel letters)			
If mounting individual letters, space between letters	1-2"		
If mounting individual letters, space between words	1-2"		
If window sign, size of window			
If changeable copy sign (reader board), number of lines			
If freestanding sign, distance between sign and street curb (ft)	25 ft		
If freestanding sign, total height above grade (ft)	8' 6"		
If freestanding sign, landscaping materials to be planted at base of sign	Boxwood Hedges		

Review the attached Zoning Ordinances pertaining to sign regulations (Section 151.084). Be advised to examine them thoroughly so as to avoid violations (Section 151.999):

By signing below, you certify the above information that you provided to be true and correct.

  
\_\_\_\_\_  
Signature of Applicant

4-June-18  
\_\_\_\_\_  
Date

<b>OFFICE USE ONLY</b>		
Remarks: _____		
_____		
Approval: Zoning Administrator _____	Issued by: _____	Date: _____





Sign Location

2340000060

234

BL

HAMLET CIR





There are no neighbors to the left of the building.





Existing Sign- To be removed



Rejected color scheme



New Design



Colors are toned down. Planet is now a light earth tone blue and the base is brick to match building brick facade.



Kidz  
Planet

PEDIATRIC  
DENTISTRY

Swasty  
Orthodontics

Boxwood hedge  
in the shape of a square



LED lighting inside the Triangle  
so there is no glare from the road

Lights are already in place from the old business's sign.



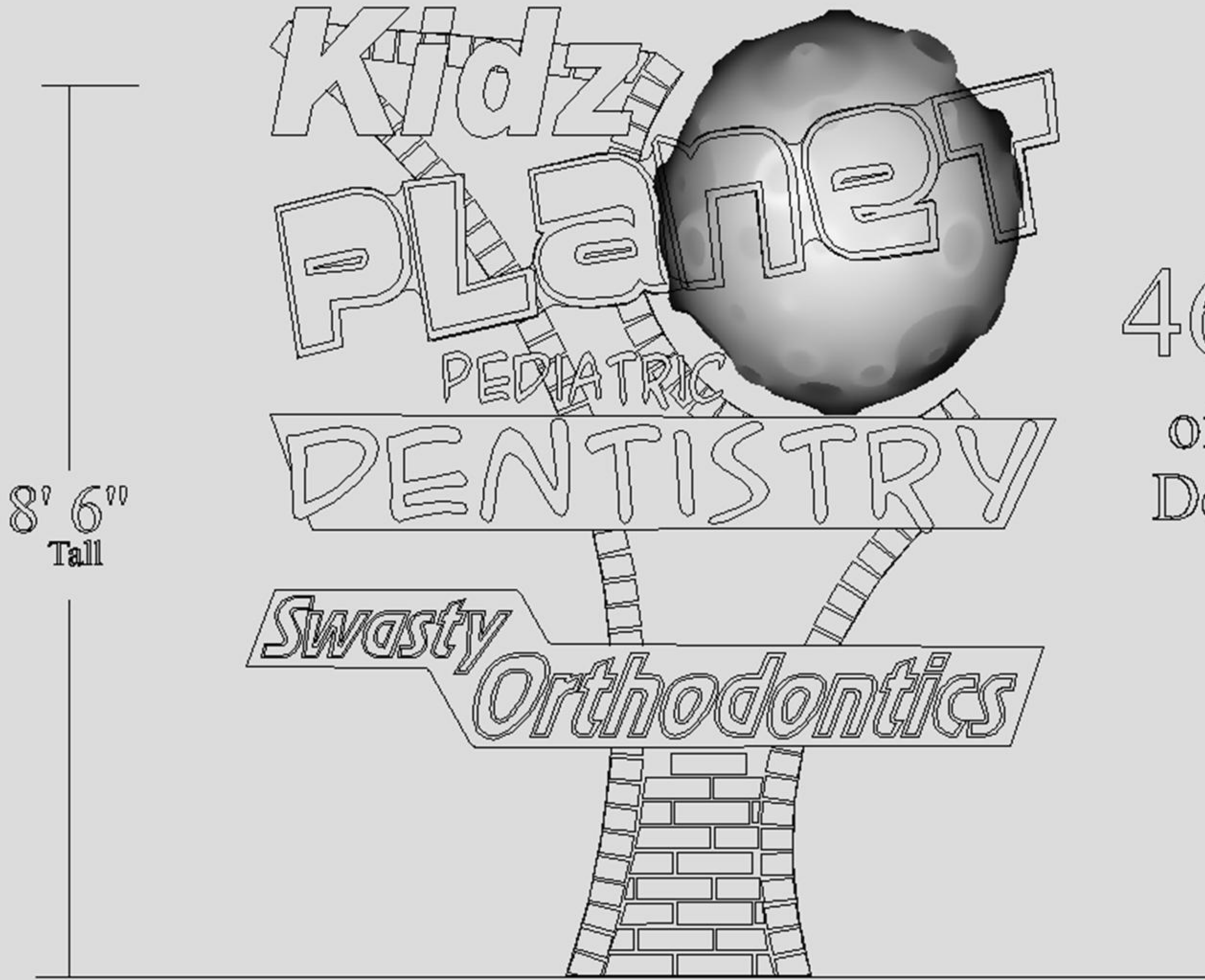

46 sq/ft  
of sign face  
Double sided

Goose Creek Building Dept  
said not to exceed 10' tall  
and 50sq/ft of sign face

100 Hamlet Circle  
New owner Sign Request



## ARCHITECTURAL REVIEW BOARD: SCOPE OF WORK

---

**PROJECT:** Metro North Church

**LOCATION:** 109 Central Ave.

The applicant will be presenting elevations showing the re-roof and new proposal of a gray color in lieu of the green.





## ARCHITECTURAL REVIEW BOARD: SCOPE OF WORK

---

**PROJECT:** Bank of America

**LOCATION:** 212 St James Ave.

The applicant will be presenting elevations showing the re-placement of the ATM machine.





FRAME UB4 BUILDING WITH NCR 6688 ATM  
 BANK OF AMERICA  
 GOOSE CREEK  
 212 SAINT JAMES AVE  
 GOOSE CREEK, SC 29445

**TOP OF CANOPY TO HAVE  
 COOL ROOF COATING**

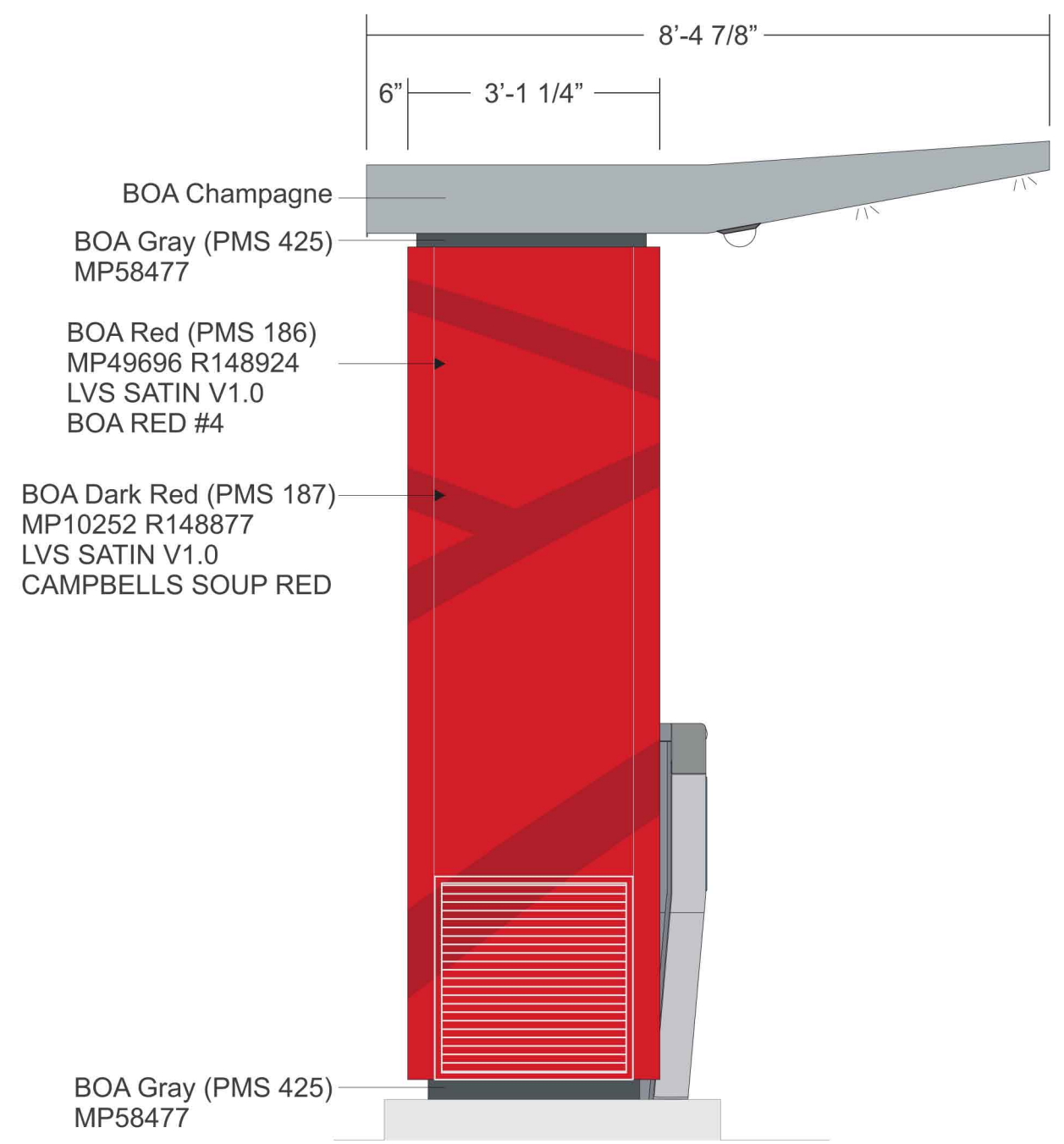

Approach (Left Side)



Front View (NCR 6688)



Scale 1/2" = 1'-0"

**CONCEPT UNLIMITED, Inc.**  
 10020 Farrow Rd. Columbia, SC 29203  
 Phone (803) 755-9100

**Revision:**  
 R1 8/26/16 Revised Garbo Silver color specs.  
 R2 11/8/16 Added MP numbers to layout.  
 R3 1/26/17 Add location of security camera and lights.

**FRAME-R-UB-DU-N6688**

THIS IS AN ORIGINAL DESIGN SUBMITTED BY CONCEPT UNLIMITED FOR YOUR PERSONAL USE. IT IS NOT TO BE SHOWN TO ANYONE OUTSIDE YOUR ORGANIZATION, NOR IT IS TO BE USED, COPIED, REPRODUCED, OR EXHIBITED IN ANYWAY WHATSOEVER. ALL OR ANY PART OF THIS DESIGN (EXCEPT REGISTERED TRADE-MARKS) REMAIN THE PROPERTY OF CONCEPT UNL. INC.

Customer: BANK OF AMERICA  
 Salesman: Aaron Carrico  
 Drawn By: TGP  
 Date: 8/26/2016  
 Drawing No: **A10726**  
 Pg. 1 of 20

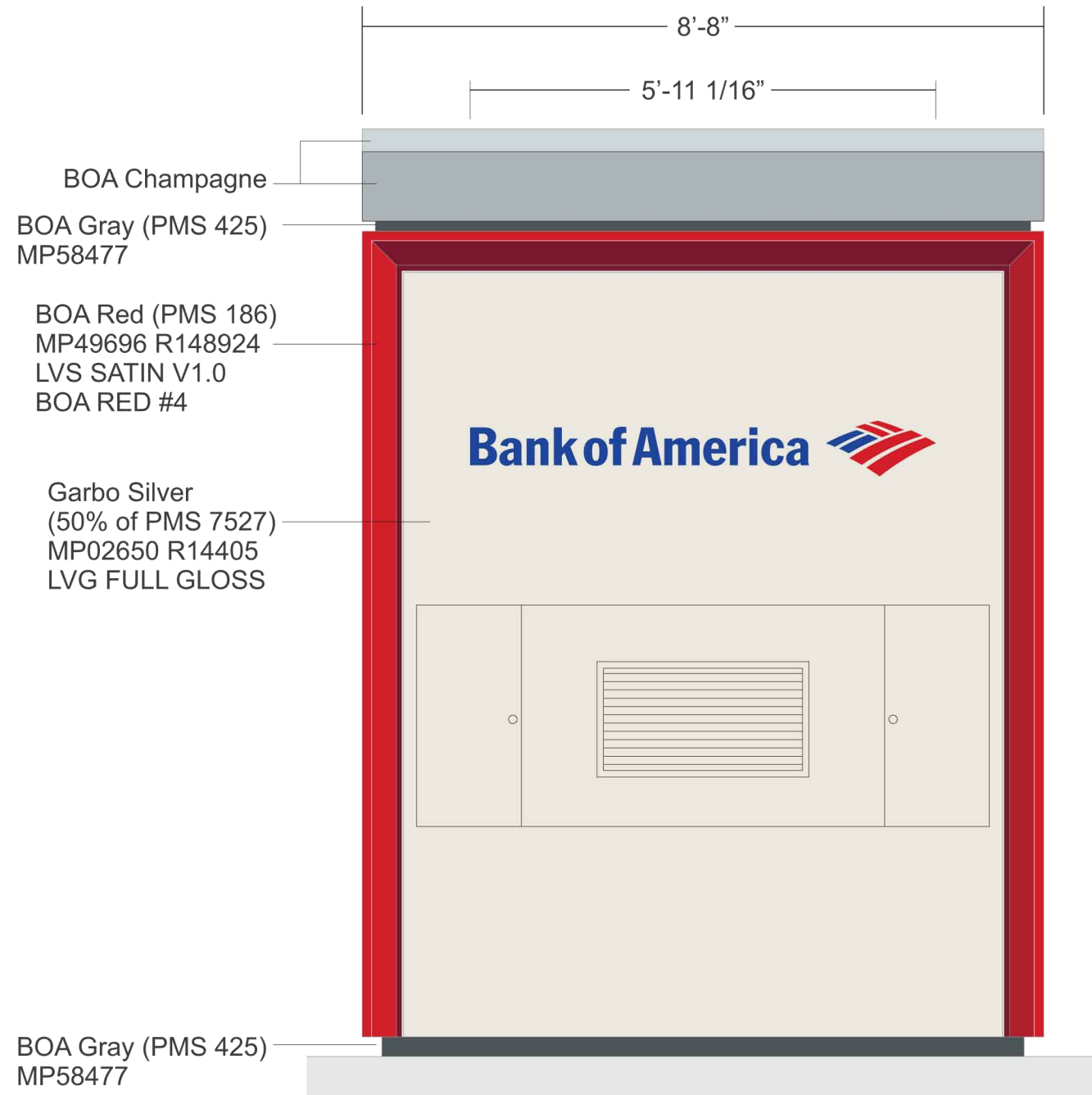

Rear View

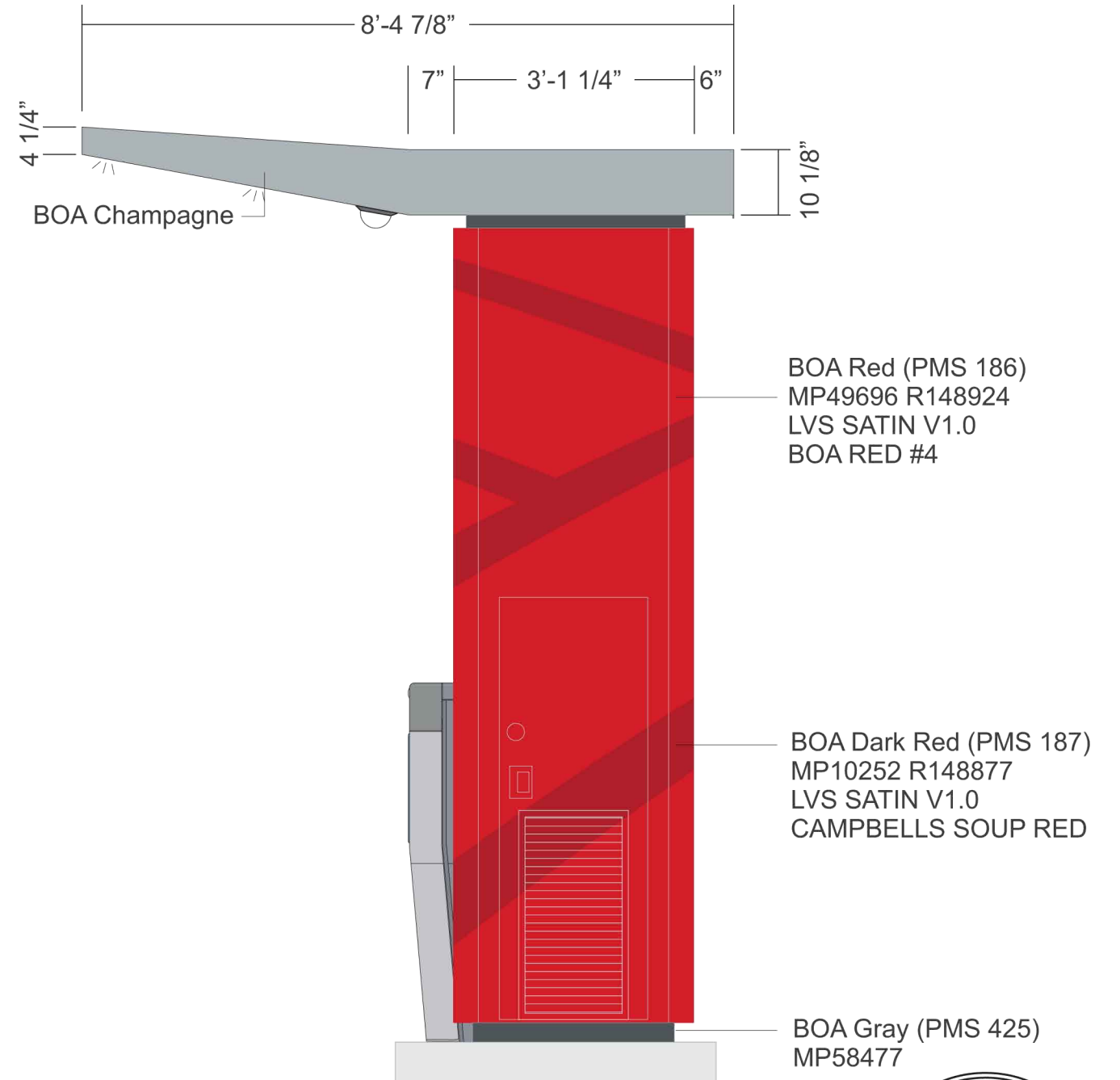

Right Side

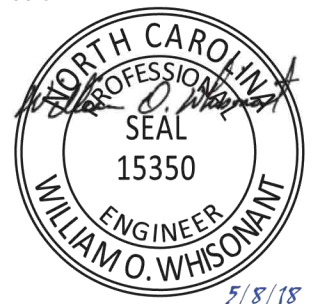

Scale 1/2" = 1'-0"



**Revision:**  
 R1 8/26/16 Revised Garbo Silver color specs.  
 R2 11//8/16 Added MP numbers to layout.  
 R3 1/26/17 Add location of security camera and lights.

**FRAME-R-UB-DU-N6688**

THIS IS AN ORIGINAL DESIGN SUBMITTED BY CONCEPT UNLIMITED FOR YOUR PERSONAL USE. IT IS NOT TO BE SHOWN TO ANYONE OUTSIDE YOUR ORGANIZATION, NOR IT IS TO BE USED, COPIED, REPRODUCED, OR EXHIBITED IN ANYWAY WHATSOEVER. ALL OR ANY PART OF THIS DESIGN (EXCEPT REGISTERED TRADEMARKS) REMAIN THE PROPERTY OF CONCEPT UNL. INC.

Customer: BANK OF AMERICA  
 Salesman: Aaron Carrico  
 Drawn By: TGP  
 Date: 8/26/2016  
 Drawing No: **A10726**  
 Pg. 2 of 20