



THE CITY OF
GOOSE CREEK

BERKELEY CO. EST. 1961 SO. CAROLINA

**SUPPORTING MATERIALS FOR
ARCHITECTURAL REVIEW BOARD
MONDAY, JULY 19, 2021
6:00 PM**

**MARGUERITE BROWN MUNICIPAL CENTER
CITY HALL COUNCIL CHAMBERS
519 N. GOOSE CREEK BLVD.
GOOSE CREEK, SOUTH CAROLINA**

MEMORANDUM

TO: MEMBERS OF THE ARCHITECTURAL REVIEW BOARD

FROM: LILI ORTIZ-LUDLUM, ADMINISTRATIVE ASSISTANT

DATE: July 14, 2021

SUBJECT: MEETING NOTIFICATION

WHERE: MARGUERITE H. BROWN MUNICIPAL CENTER

This is to remind everyone that the next meeting of the Architectural Review Board is scheduled for Monday, July 19, 2021 at 6:00 p.m.

Please review the enclosed packet. Should you have any questions or comments prior to Monday's meeting, please do not hesitate to contact Brenda Moneer, Planning and Zoning Technician (x1116) or Mark Brodeur, Planning and Zoning Director(x.1118) at 843-797-6220.



MINUTES



**MINUTES
CITY OF GOOSE CREEK
ARCHITECTURAL REVIEW BOARD MEETING
MONDAY, JUNE 21, 2021, 6:30 P.M.
MARGUERITE H. BROWN MUNICIPAL CENTER
519 N. GOOSE CREEK BOULEVARD**

I. CALL TO ORDER, PLEDGE OF ALLEGIANCE AND ROLL CALL

Chairperson Dresel called the meeting to order at 6:30 p.m. and initiated the Pledge of Allegiance. Mrs. Moneer initiated roll call.

Present: Ricky Dresel, Gary Becker, David Cantrill, Sharon Clopton, Mary Kay Soto, Teri Victor

Absent: Jen Wise

Staff Present: Planning and Zoning Technician Brenda Moneer

II. APPROVAL OF MINUTES - MAY 17, 2021

Motion: A motion was made to accept the minutes as submitted. **Moved by** Board Member Clopton, **Seconded by** Board Member Cantrill.

Discussion: None.

Vote: All voted in favor (6-0). Motion carried.

III. MINOR APPLICATIONS - NEW BUSINESS

A. 2021-038 SIG: BLUE TEQUILA: 121 PLANTATION NORTH BLVD, UNIT A - SIGNAGE

A representative was not present. The board revisited this item later in the meeting.

B. 2021-040 SIG: DREAM LEARNING ACADEMY: 100 S. GOOSE CREEK BLVD - SIGNAGE

Mr. Hugh Welch with Carolina Moon Signs presented the application. He stated the sign will be lowered to a height of 10 feet and will be printed vinyl. Mr. Welch stated the size of the boxes will remain the same. Discussion regarding the line of vision for cars ensued due to shrubbery and the sign being lowered. The board stated the address will need to be included on both sides of the sign. The board shared their concerns with how the building will look. Concerns were raised as Mr. Welch stated Dream Learning Academy have already installed new exterior doors for classrooms. The board stated this modification did not come before them for approval.

Motion: A motion was made to table the decision on Dream Learning Academy until the board receives information about their plans for the exterior of the building. **Moved by** Board Member Clopton, **Seconded by** Board Member Becker.

Discussion: Board Member Clopton stated if they are making changes to the exterior of the building it needs to come before the board for approval. She stated we need color and materials samples. Board Member Dresel stated the board needs to see the proposed signed with the renderings of the new building. It was stated there is not a problem with the sign, they just want to see how it fits with the building. It was stated the address needs to be included in the new rendering of the signs.

Vote: All voted in favor (6-0). Motion carried.

C. 2021-041 SIG: CREEK CITY GRILL/WIDE AWAKE BREWING COMPANY: 101 BUTTON HALL – SIGNAGE

Mr. Hugh Welch with Carolina Moon Signs presented the application. He stated this is a standard channel letter sign with white letter and black trim. The applicant is looking to have two (2) different signs as these are two (2) different businesses. Mr. Welch stated the building is a hundred feet long. He stated one (1) sign is fifty-one (51) square feet and the other is forty-six (46) square feet.

Motion: A motion was made to approve the application as submitted. **Moved by** Board Member Clopton, **Seconded by** Board Member Cantrill.

Discussion: It was inquired if a street sign was also being proposed. Mr. Welch stated no, as of right now only the building signs are being proposed.

Vote: All voted in favor (6-0). Motion carried.

IV. NEW BUSINESS: MAJOR APPLICATIONS

A. 2021-042 RENO: MILLER CONWAY LAWYERS: 124 S. GOOSE CREEK BLVD – SECOND FLOOR ADDITION RENOVATION

Mr. Adam Ferrara with Ferrara Buist Contractors presented the application. He stated they are proposing adding a second floor to the top of the Miller Conway Lawyers as a continuation of the Goose Creek Family Dentistry that was already approved. He presented a rendering of what the board already approved. He stated they are continuing this to the back half of the building.

The board was concerned with utilities and HVAC. The applicant stated there is only one HVAC that will be added to the back half of the building. The applicant stated shrubbery will be added to match what has already been approved to screen the new HVAC unit. The board inquired if an emergency exit will be added from the lawyer's office. Mr. Ferrara stated they are adding a single stair inside. He stated there is not enough occupant load to require two sets of stairs.

Mrs. Moneer read Mr. Brodeur's Staff Report into the record.

The Site Plan:

It may not be readily apparent, but the Site Plan for this project remains the same. The existing parking on-site is adequate to allow the additional building square footage.

The Architecture:

The proposal before ARB is to extend the recently approved second floor over the entire first floor. You may recall, the previous submittal was for a second floor over the Dentist office only.

Staff extended the deadline of the submittal of this project to accommodate the applicant. Unfortunately, we cannot comment on the architecture of the second floor because we have yet to see a color rendering of what the building will look like with a FULL second floor.

ARB approved the partial second floor with conditions to strengthen the appearance of the building. Staff recommends that the ARB take a critical look at this new second floor extension and require the same level of quality that was suggested for the first half.

Recommendation:

Staff recommends that the ARB consider placing the same type of requirements on this half of the second floor that were required on the first half. These include a beefier cornice, window surrounds and other window enhancements.

Board Member Dresel shared his concerns. He stated he feels the application is incomplete. He stated it is basically the same drawing we looked at last time just transposed over. Location of HVAC, landscaping, and signage details are not presented on the rendering provided. Board Member Dresel stated an extension was given for the submission and these details still were not added. Board Member Becker agreed with Board Member Dresel.

The applicant stated we took all the guidance that was approved for the prior submittal and included it on this application. He stated we did not have the HVAC on the prior submittal, we demonstrated where it was going to be placed and how we were going to protect it with shrubbery and that was okay. The applicant apologized for not providing a color rendering. He stated the focus is not to put something up that is haphazard and rushed. He stated the entire goal is not build the project twice. He stated he is trying to be reasonable and fair to the project and the business owners.

Board Member Dresel stated we want to keep the businesses in mind also, but with that kind of urgency he would have expected a complete application. Last time we asked for landscaping and got it on the second submission of that project, he stated he would have expected it on the first submission this time.

The applicant asked what the board wants to see regarding screening for HVAC. Board Member Becker made a few suggestions regarding bushes, fencing, or materials that match the building.

Motion: A motion was made to deny the application until current elevations are provided showing in detail their proposal. **Moved by** Board Member Clopton, **Seconded by** Board Member Becker.

Discussion: Board Member Becker stated the resubmission should include screening. Board Member Clopton stated we want to see more detail.

Vote: Board Member Dresel, Board Member Becker, Board Member Clopton, Board Member Soto and Board Member Victor voted in favor. Board Member Cantrill opposed (5-1). Motion carried.

The board revisited **2021-038 SIG BLUE TEQUILA**. Mrs. Moneer stated the applicant did request to present their application via zoom. She stated we are no longer doing zoom presentations. Mrs. Moneer stated staff calculated that each sign is really 45.7 square feet in total which is an allowable amount because of the width of the building. She stated they are allowed 97.2 square feet of signage; this brings them to 91.46 with both signs.

Motion: A motion was made to accept the application as submitted. **Moved By:** Board Member Soto, **Seconded By:** Board Member Victor.

Discussion: There was none.

Vote: All voted in favor (6-0). Motion carried.

V. CLOSING REMARKS AND ADJOURNMENT

The board resumed discussion regarding the second-floor addition to Miller Conway Lawyers. Board Member Cantrill inquired how to clarify screening for HVAC. Mrs. Moneer stated screening should complement the primary structure. Mr. Brian Cook, Assistant City Administrator, introduced himself. He stated we are looking to redo the Zoning Ordinance in the near future. He stated we will be looking specifically at potential overlay districts for the city. He stated ideally, we will create a design guideline booklet that is either specific to the entire city or specific to the overlay district if Council approves it.

Motion: A motion was made to adjourn (7:36p.m.) **Moved By:** Board Member Becker, **Seconded By:** Board Member Victor.

Discussion: There was none.

Vote: All voted in favor (6-0). Motion carried.

_____ Date _____
Ricky Dresel, Chairperson



NEW BUSINESS: MINOR APPLICATIONS

2021-045 SIG

SC FEDERAL CREDIT UNION

SIGNAGE



CITY OF GOOSE CREEK
SIGN PERMIT APPLICATION

PAID

PERMIT #: 044097	OFFICE USE ONLY
AMOUNT DUE: \$ 75.00	DATE PAID: 06/30/21
LICENSE#: 02701	DATE PAID: 06302021

Permit Fee: \$75.00

Today's Date: 6/21/2021

1. Business Owner SC Federal Credit Union Business Phone [REDACTED]
 Name of Business SC Federal Credit Union Alternate Phone _____
 Street Address of Business 82 Bridgetown Rd
 Landlord/Lessor NA Landlord's Phone _____
 Sign Company Miller Signs Sign Co. Phone [REDACTED]
 Sign Co. Contact Shelby Bates Sign Co. Address [REDACTED]

2. Cost of Sign(s) \$ _____ Sign Installation Cost \$ _____ Total Cost \$ _____

3. How many signs are you applying for? 16 How many signs does this business already have? 16

4. What kind of signs does this business already have? illum. monuments, directional, wall None

5. What type of business is applying for this sign permit:
 A. A stand alone business? Yes No
 B. A part of a shopping center? Yes No If yes, shopping center name: _____

6. What is the TMS number for this property? _____ - _____ - _____

7. What is the front setback of the business in feet? 238 (The distance from the front property line to the front of business)
 A. For corner lots only, what is the front setback for second street frontage in feet? 105

8. What is the width of the business in feet? 90 (The distance from wall to wall)
 A. For corner lots only, what is the width of the business for second street frontage in feet? 81.4

9. What is the property's road frontage in feet? _____ (This only applies to shopping centers erecting a freestanding sign)

10. Please attach photos showing:
 A. The storefront in relation to adjacent businesses;
 B. The specific location of proposed sign(s) on the property or building; and
 C. The actual sign if it already exists.

11. Please attach drawings of each proposed sign showing (drawn to scale) :
 A. The completed sign as it will actually appear on the building
 B. All dimensions;
 C. Where the colors will appear;
 D. The location on the property (on a plat) of proposed & existing freestanding signs
 E. The location on the building of proposed & existing building signs

12. Please attach swatches, samples, and/or paint chips of all proposed colors to the application

13. Please complete the Sign Information Table located on the following page.

14. You are required to attend the Architectural Review Board meeting in which your sign application is reviewed.
 • Please submit this application by the 1st Monday of the month for consideration that month by the ARB.
 • The ARB meets on the 3rd Monday of each month. (Please see attached ARB schedule for application deadlines and meetings.)

OFFICE USE ONLY
MAX. NO. OF ALLOWED SIGNS: <u>7</u>
MAX ALLOWED SIGN AREA: <u>268.8sf</u>

sign permit application meets ordinance criteria as outlined in section 151.084 of the City Zoning Ordinance. Please add to July 19th ARB meeting Agenda.

[Signature]

NOTE: Illuminated, exposed and non-exposed neon signs located on the interior of a business, which are visible from the exterior of the business, must be reviewed by the ARB. Such signs shall be included as part of a business's maximum allowable square footage of building signage, as authorized in Section 151.084 of the City Code. A "non-exposed neon sign" shall be interpreted as a neon sign that does not have externally visible neon tubing. Neon signs enclosed in plastic, glass and Plexiglas casings are considered "exposed neon signs." All electrical work must be in accordance with the City's Code of Ordinances and the National Electrical Code.

Note: This application contains multiple pages

SIGN INFORMATION TABLE

Required Information	Sign 1 Qty 2	Sign 2 Qty 3	Sign 3 Qty 3
Materials: (metal, plastic, wood, etc.)	Cabinet Replacement Alum/Acrylic	Alum/Acrylic	aluminum
Illumination: Exterior, interior or not lighted	LED interior	LED Interior (HALO)	LED interior (HALO)
Type of Sign:	EXISTING - REPLACES CABINET MONUMENT	WALL	WALL
Height (FEET)	3	3	9.08
Width (feet)	6.167	10'-1"	6.42
Area (square feet)	18.5 (Sign)	90.75	(58.3ea) 174.9
All colors used on sign	SILVER, WHITE Black, Blue	Blue	Blue
Is there a graphic (picture) on the sign? (Y/N) If yes, size of graphic	14" x 9"	NO GRAPHIC	This is the logo
Projection from building or cabinet width (thickness)	12"	5"	5"
Number of styles of lettering	1	1	logo
Height of letters (if channel letters)	—	VARIOUS - LARGEST = 1 1/2"	—
If mounting individual letters, space between letters	—	1/2"	—
If mounting individual letters, space between words	—	2"	—
If window sign, size of window	—	NA	—
If changeable copy sign (reader board), number of lines	—	NA	—
If freestanding sign, distance between sign and street curb (ft)	25 33	—	—
If freestanding sign, total height above grade (ft)	8	—	—
If freestanding sign, landscaping materials to be planted at base of sign	Sweetgrass Creeping Lortope Dwarf Palms Seasonal plantings	—	—

Review the attached Zoning Ordinances pertaining to sign regulations (Section 151.084). Be advised to examine them thoroughly so as to avoid violations (Section 151.999). →

By signing below, you certify the above information that you provided to be true and correct.

Shelby M. Bates
Signature of Applicant

6/28/2021
Date

OFFICE USE ONLY	
Remarks: _____	

Approval: Zoning Administrator _____	Issued by: _____ Date: _____

SIGN INFORMATION TABLE

→ All to replace existing

Required Information	Sign 1 ⁴	Sign 2	Sign 3
Materials: (metal, plastic, wood, etc.)	Qty 7 alum		
Illumination: Exterior, interior or not lighted	NON-ILLUMINATED		
Type of Sign:	Directional		
Height (FEET)	1'-2"		
Width (feet)	2'-6"		
Area (square feet)	2.9		
All colors used on sign	Blue/White (Silver Postcover)		
Is there a graphic (picture) on the sign? (Y/N) If yes, size of graphic	Y - 6"		
Projection from building or cabinet width (thickness)	—		
Number of styles of lettering	1		
Height of letters (if channel letters)	—		
If mounting individual letters, space between letters	—		
If mounting individual letters, space between words	—		
If window sign, size of window	—		
If changeable copy sign (reader board), number of lines	—		
If freestanding sign, distance between sign and street curb (ft)			
If freestanding sign, total height above grade (ft)	2'-6"		
If freestanding sign, landscaping materials to be planted at base of sign			

Review the attached Zoning Ordinances pertaining to sign regulations (Section 151.084). Be advised to examine them thoroughly so as to avoid violations (Section 151.999):

By signing below, you certify the above information that you provided to be true and correct.

Shelby M. Bates
Signature of Applicant

6/28/2021
Date

OFFICE USE ONLY

Remarks: _____

Approval: Zoning Administrator _____ Issued by: _____ Date: _____

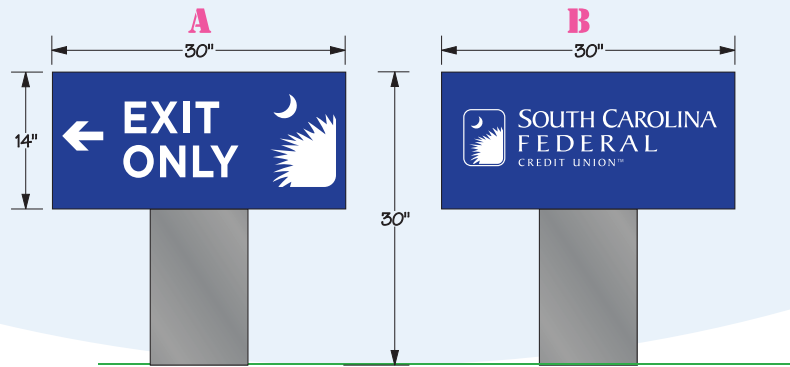
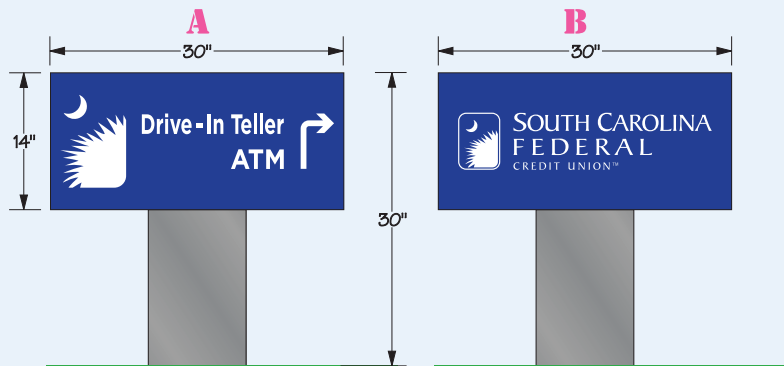
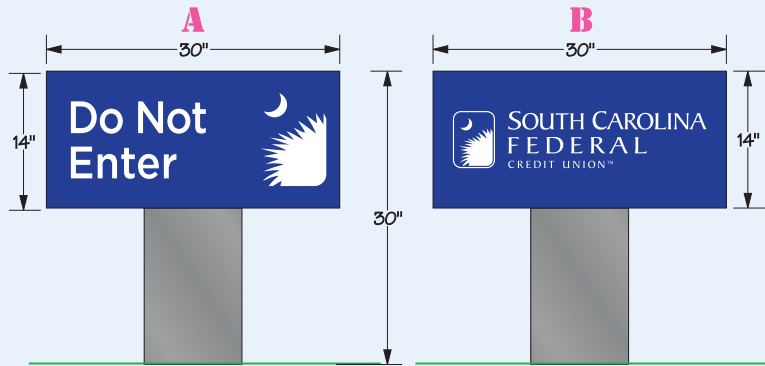
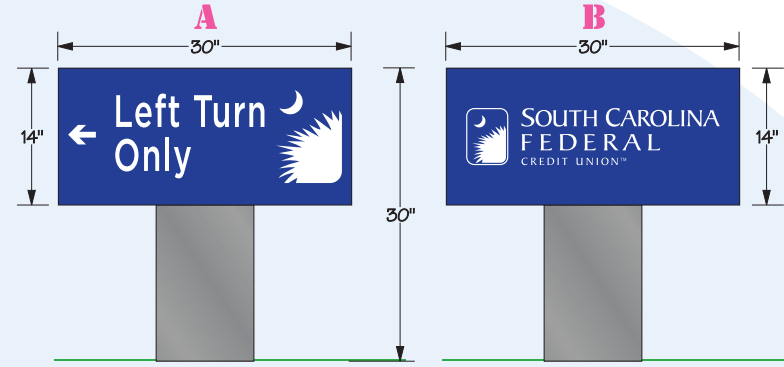
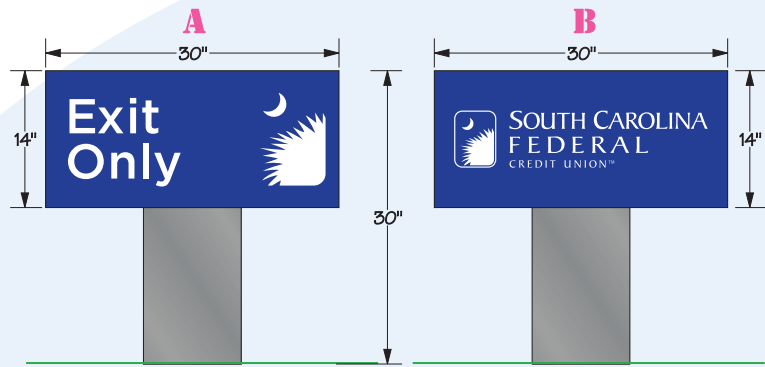

scale 1/2" = 1'

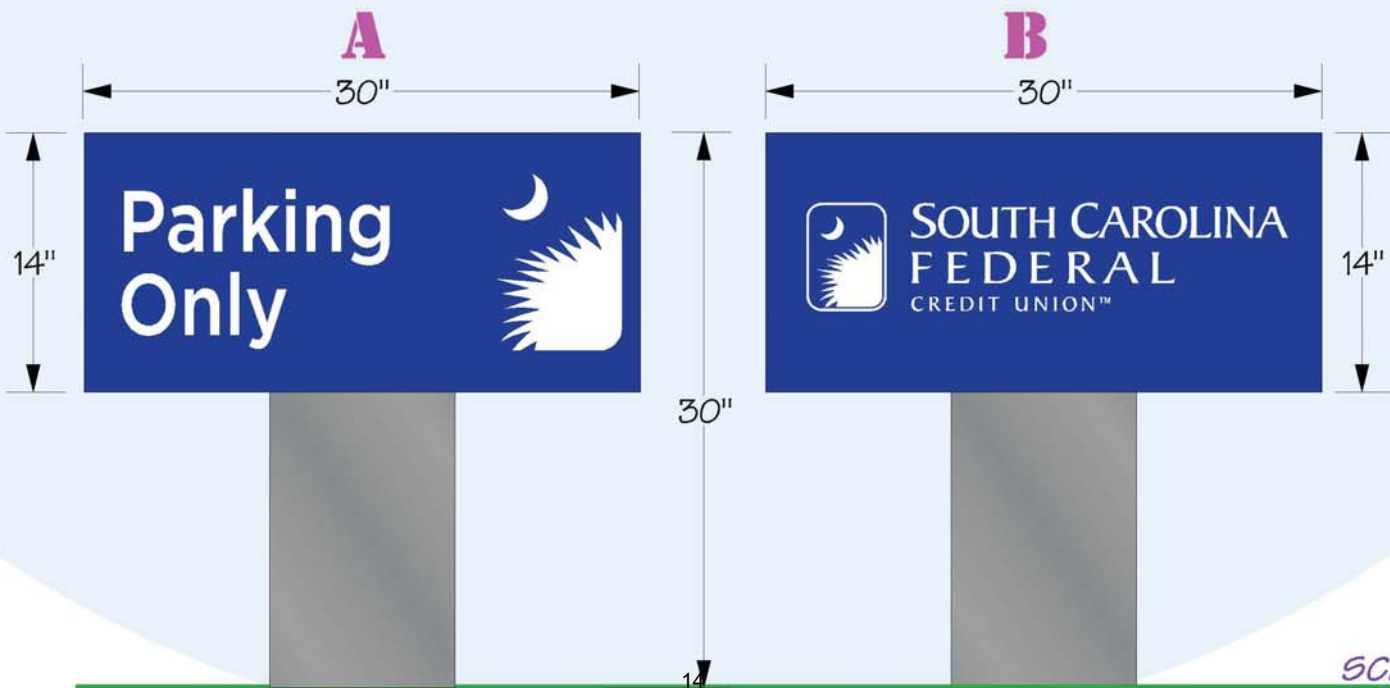
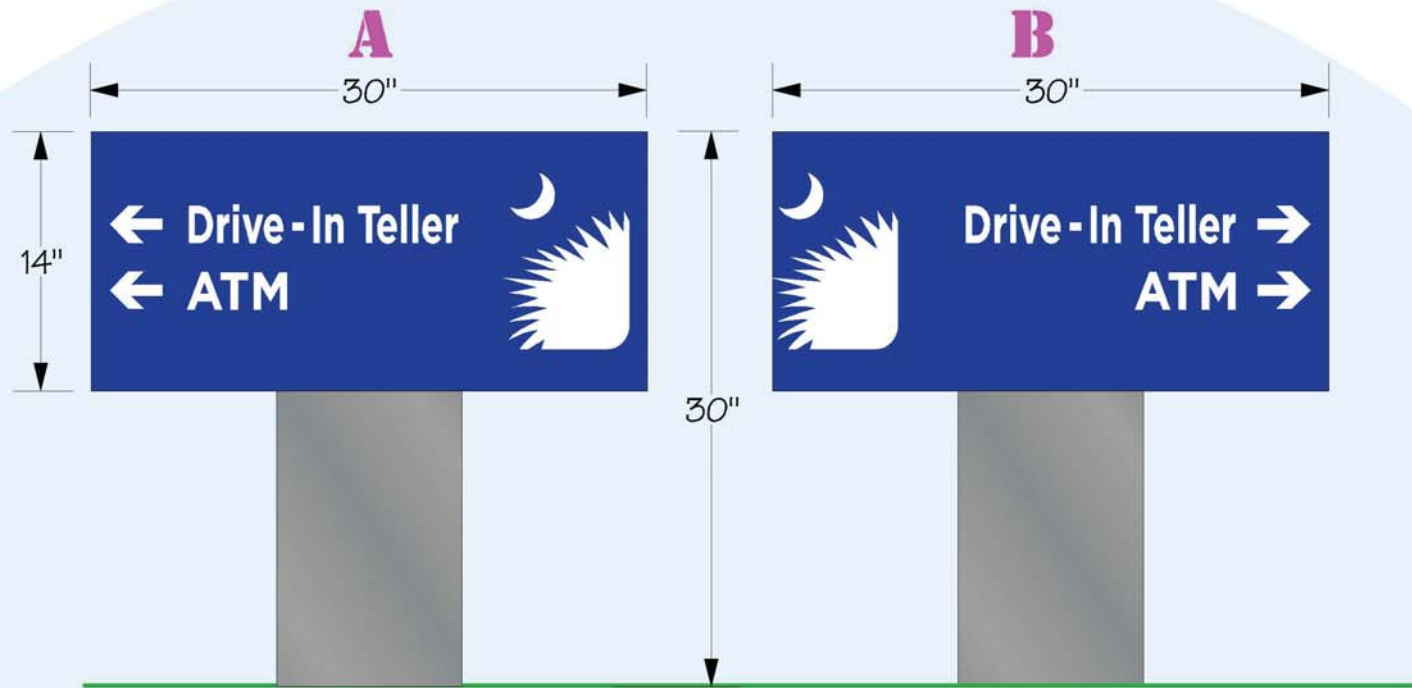

scale 1" = 1'

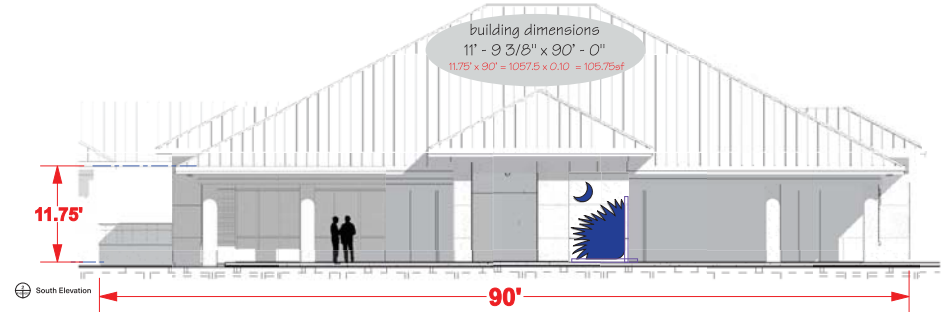
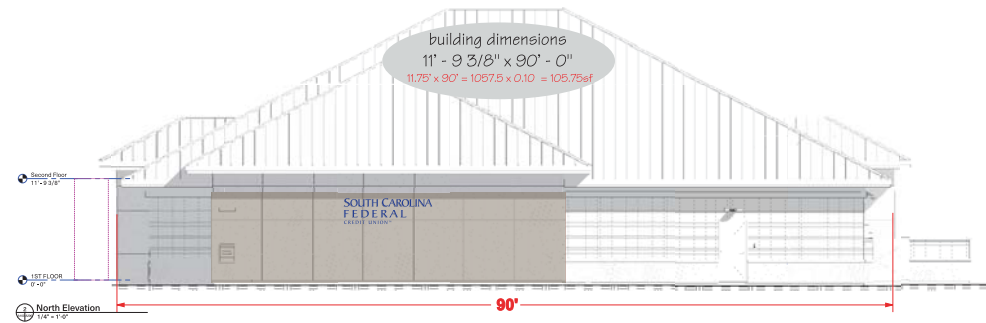
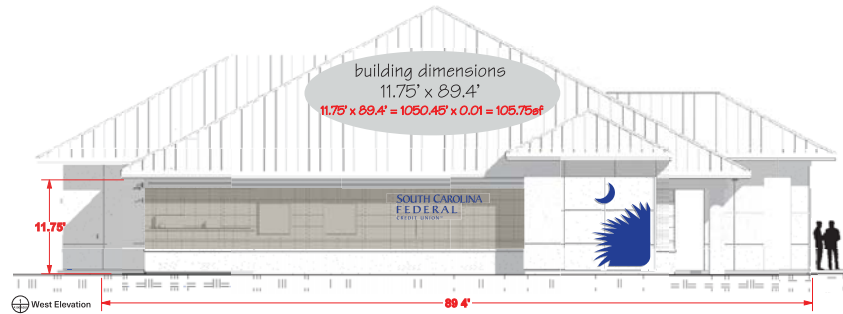
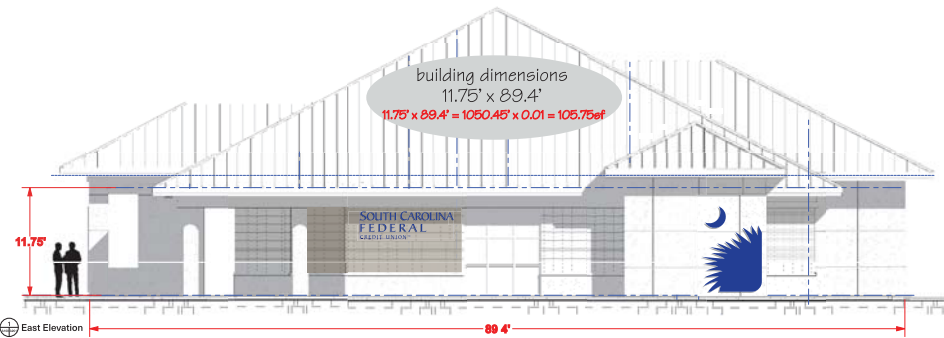

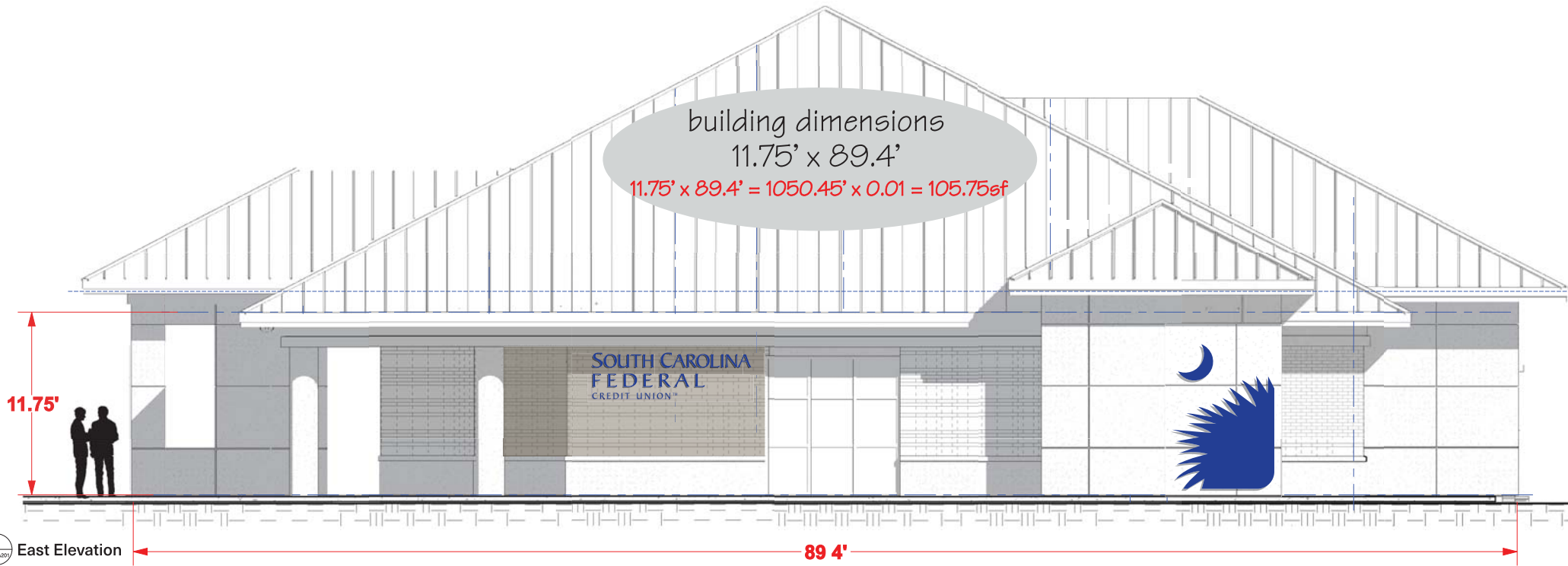

$121'' \times 36'' = 4,356 / 144 = 30.25sf.$

typical installation of illuminated reverse channel letters
& reverse lit logo - bottom copy stud mount PVC letters

matthews paint:
286c - scfu blue

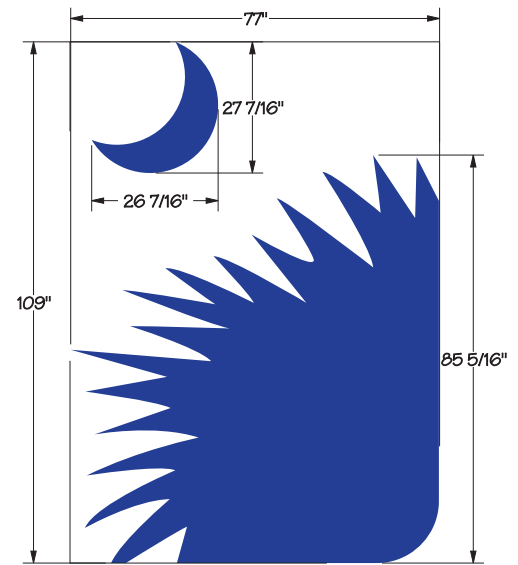
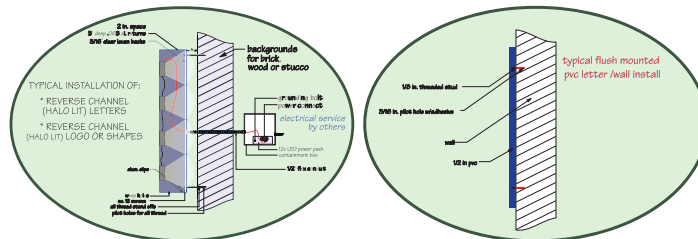

$109'' \times 77'' = 8,393 / 144 = 58.3sf$

scale 1/4" = 1'

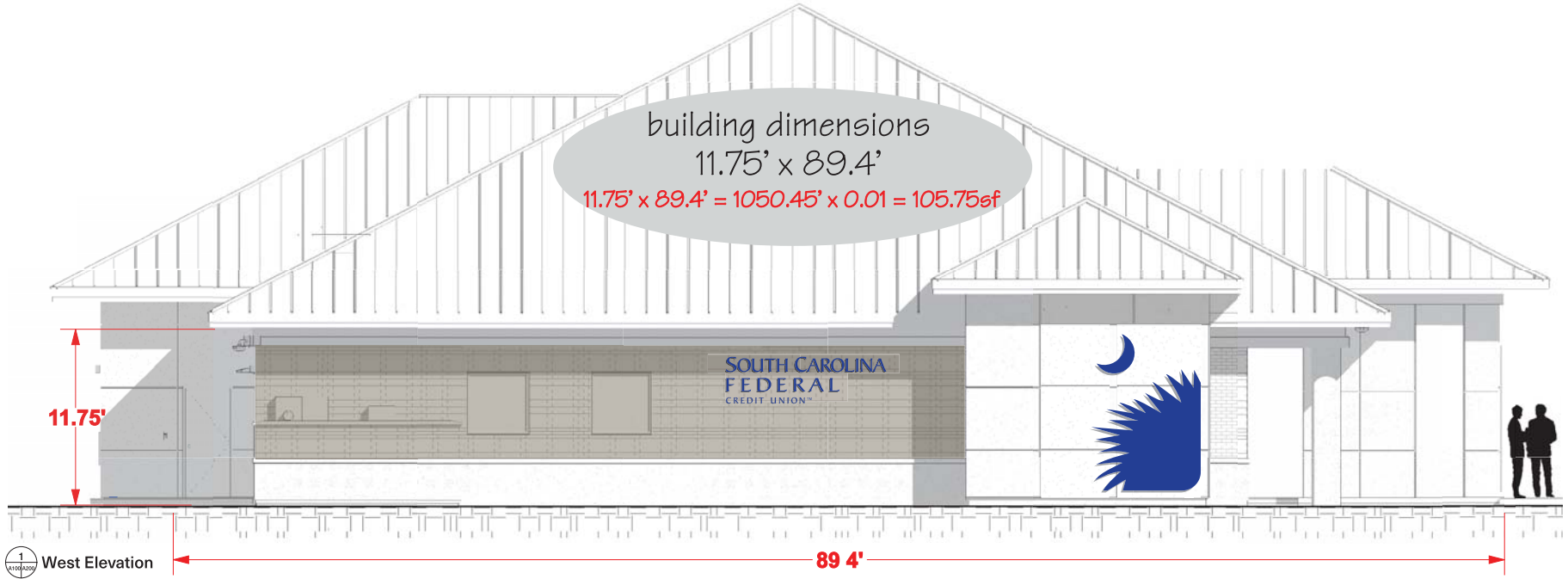

building dimensions

11.75' x 89.4'

11.75' x 89.4' = 1050.45' x 0.01 = 105.75sf

11.75'

1 West Elevation

89.4'



121" x 36" = 4,356 / 144 = 30.25sf.

typical installation of illuminated reverse channel letters & reverse lit logo - bottom copy stud mount PVC letters

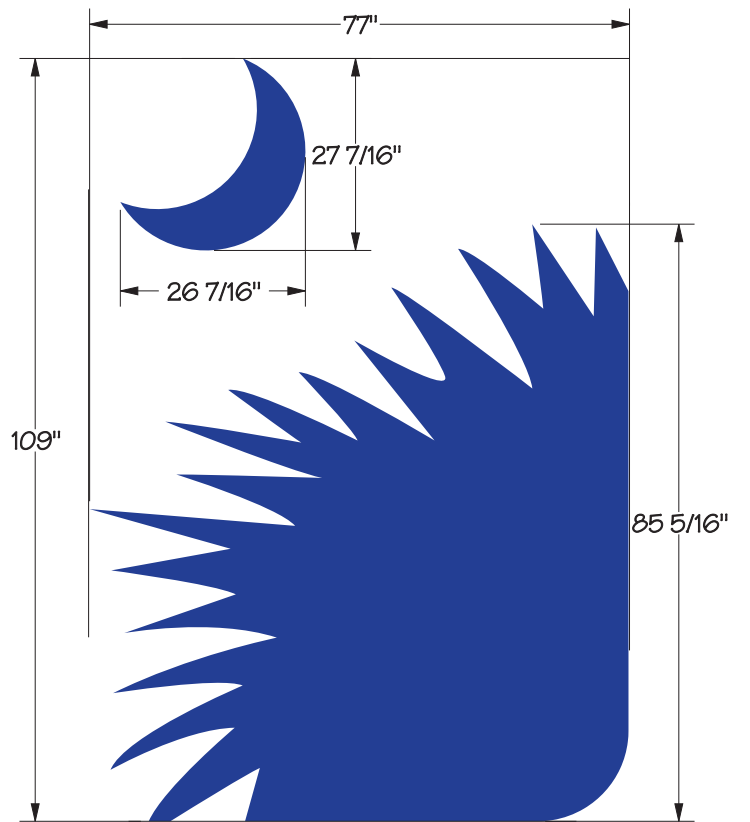

109" x 77" = 8,393 / 144 = 58.3sf

matthews paint:
286c - scfcu blue

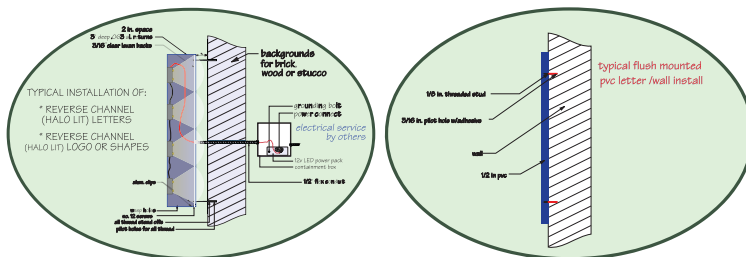

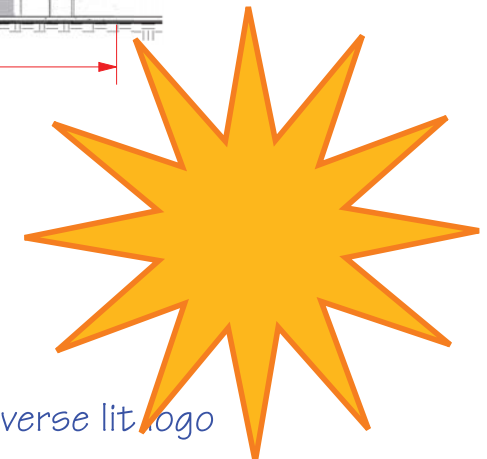
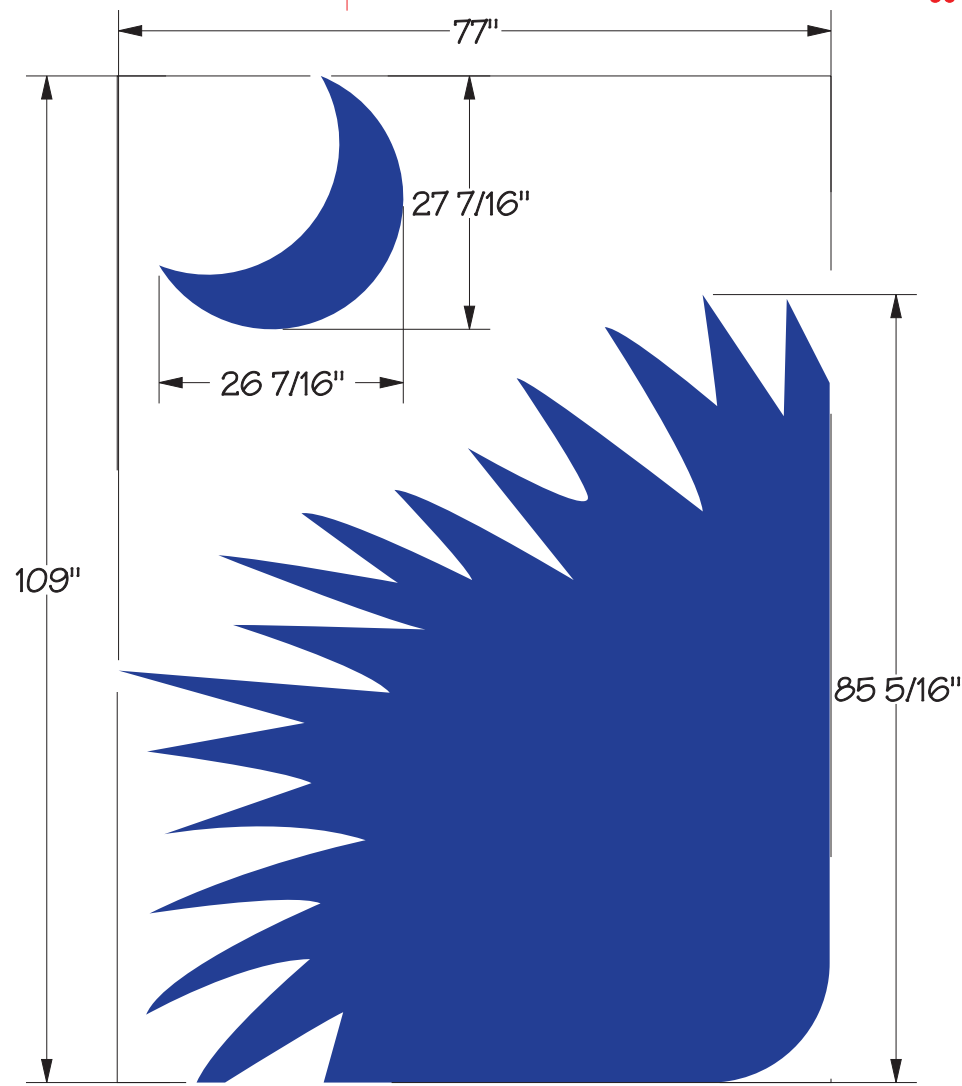
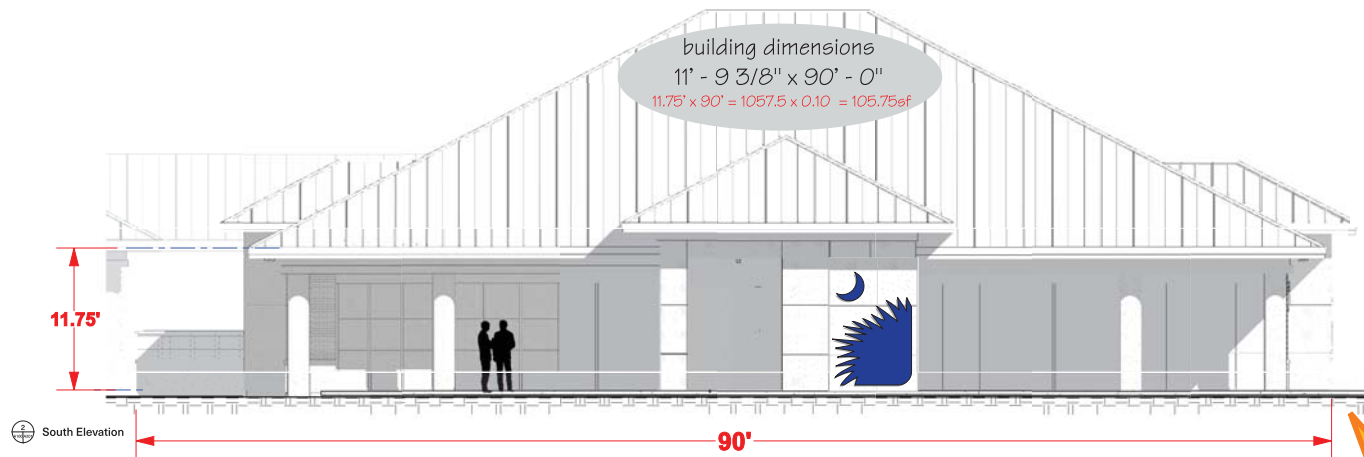

typical installation of reverse lit logo

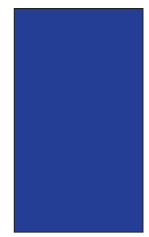
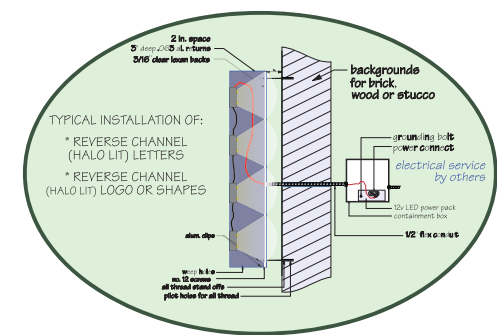

matthews paint:
286c - scfcu blue

$109'' \times 77'' = 8,393 / 144 = 58.3sf$

scale 1/2" = 1'



2 retrofit signs (all same size 1. single faced 2. double faced) to fit existing brick columns

2 sided

1 sided

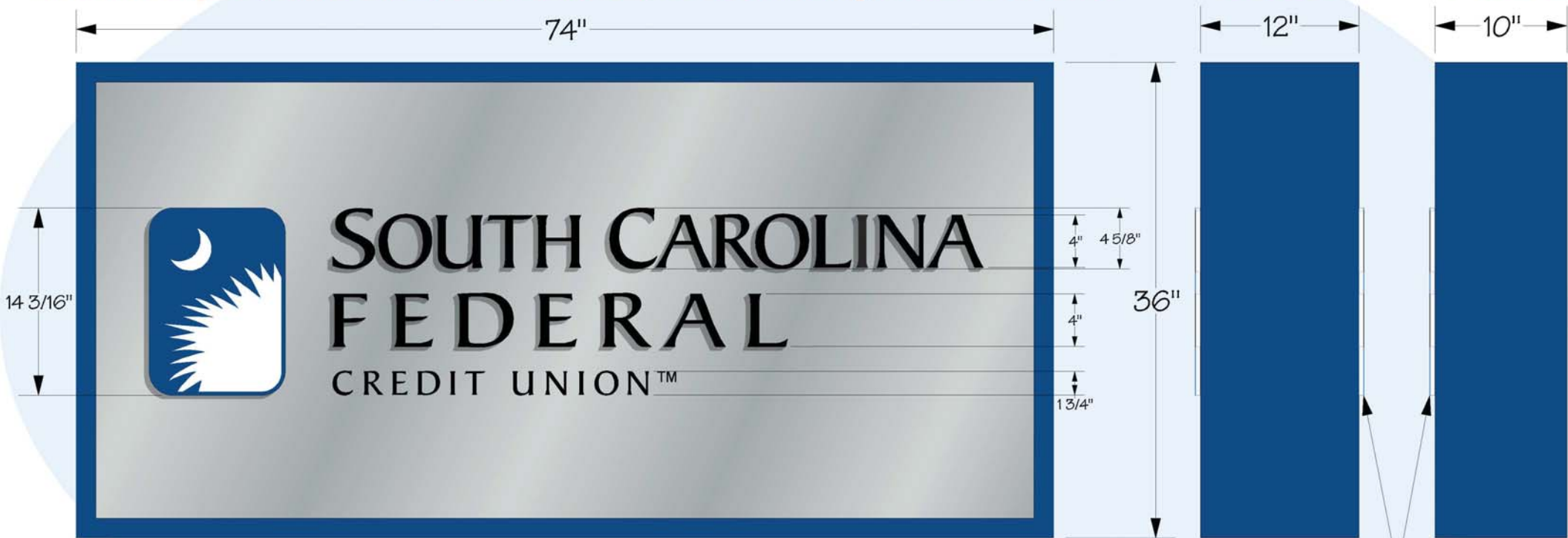

1 1/2" alum. angle cabinet, alum. retainers, .080 routed aluminum face, 3/8" acrylic letters (LOGO, SOUTH CAROLINA FEDERAL) & interior LED illumination

scale 1" = 1'



NEW BUSINESS: MINOR APPLICATIONS

2021-047 SIG

OUTLAW BARBER COMPANY

SIGNAGE



CITY OF GOOSE CREEK
SIGN PERMIT APPLICATION

PAID

PERMIT #: 044118	OFFICE USE ONLY
AMOUNT DUE: \$ 75.00	DATE PAID: 7/6/21
LICENSE#: _____	DATE PAID: / /

Permit Fee: \$75.00

Today's Date: 6/30/21

1. Business Owner Joey Easterlin Business Phone [REDACTED]
 Name of Business Outlaw Barber Company Alternate Phone _____
 Street Address of Business 119 Plantation North Blvd. Unit C
 Landlord/Lessor Brent Case / Coldwell Banker Landlord's Phone _____
 Sign Company Carolina Moon Signs Sign Co. Phone [REDACTED]
 Sign Co. Contact Hugh Welch Sign Co. Address [REDACTED]

2. Cost of Sign(s) \$ [REDACTED] Sign Installation Cost \$ [REDACTED] Total Cost \$ [REDACTED]

3. How many signs are you applying for? 2 How many signs does this business already have? 0

4. What kind of signs does this business already have? _____ None

5. What type of business is applying for this sign permit:
 A. A stand alone business? Yes No
 B. A part of a shopping center? Yes No If yes, shopping center name: Goose Creek Village

6. What is the TMS number for this property? 234-00-00-047

7. What is the front setback of the business in feet? 30' (The distance from the front property line to the front of business)
 A. For corner lots only, what is the front setback for second street frontage in feet? _____

8. What is the width of the business in feet? 22' (The distance from wall to wall)
 A. For corner lots only, what is the width of the business for second street frontage in feet? _____

9. What is the property's road frontage in feet? _____ (This only applies to shopping centers erecting a freestanding sign)

10. Please attach photos showing:
 A. The storefront in relation to adjacent businesses;
 B. The specific location of proposed sign(s) on the property or building; and
 C. The actual sign if it already exists.

11. Please attach drawings of each proposed sign showing (drawn to scale):
 A. The completed sign as it will actually appear on the building
 B. All dimensions;
 C. Where the colors will appear;
 D. The location on the property (on a plat) of proposed & existing freestanding signs
 E. The location on the building of proposed & existing building signs

12. Please attach swatches, samples, and/or paint chips of all proposed colors to the application.

13. Please complete the Sign Information Table located on the following page.

14. You are required to attend the Architectural Review Board meeting in which your sign application is reviewed.
- Please submit this application by the 1st Monday of the month for consideration that month by the ARB.
 - The ARB meets on the 3rd Monday of each month. (Please see attached ARB schedule for application deadlines and meetings.)

OFFICE USE ONLY
MAX. NO. OF ALLOWED SIGNS: <u>2</u>
MAX ALLOWED SIGN AREA: <u>22SF</u>

sign permit application meets ordinance criteria as outlined in section 151.084 of the City Zoning Ordinance. Please add to July 19th ARB meeting Agenda.

[Signature]

NOTE: Illuminated, exposed and non-exposed neon signs located on the interior of a business, which are visible from the exterior of the business, must be reviewed by the ARB. Such signs shall be included as part of a business's maximum allowable square footage of building signage, as authorized in Section 151.084 of the City Code. A "non-exposed neon sign" shall be interpreted as a neon sign that does not have externally visible neon tubing. Neon signs enclosed in plastic, glass and Plexiglas casings are considered "exposed neon signs." All electrical work must be in accordance with the City's Code of Ordinances and the National Electrical Code.

Note: This application contains multiple pages

SIGN INFORMATION TABLE

Required Information	Sign 1	Sign 2	Sign 3
Materials: (metal, plastic, wood, etc.)	Aluminum/Acrylic	Aluminum/Acrylic	
Illumination: Exterior, interior or not lighted	Interior	Interior	
Type of Sign:	WALL MOUNT	WALL MOUNT	
Height (FEET)	2'-1"	3'	
Width (feet)	9'-1"	2'-3"	
Area (square feet)	15.125 s/f	6.75 s/f	
All colors used on sign	Black/White	Black/White	
Is there a graphic (picture) on the sign? (Y/N) If yes, size of graphic	Yes 29" x 26"	Yes 27" w x 36" h	
Projection from building or cabinet width (thickness)	6"	6"	
Number of styles of lettering	ONE	N/A	
Height of letters (if channel letters)	11"	N/A	
If mounting individual letters, space between letters	1.25"	N/A	
If mounting individual letters, space between words	N/A	N/A	
If window sign, size of window	N/A	N/A	
If changeable copy sign (reader board), number of lines	N/A	N/A	
If freestanding sign, distance between sign and street curb (ft)	N/A	N/A	
If freestanding sign, total height above grade (ft)	N/A	N/A	
If freestanding sign, landscaping materials to be planted at base of sign	N/A	N/A	

Review the attached Zoning Ordinances pertaining to sign regulations (Section 151.084). Be advised to examine them thoroughly so as to avoid violations (Section 151.999):

By signing below, you certify the above information that you provided to be true and correct.

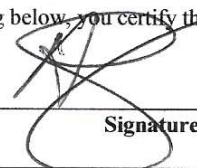

 Signature of Applicant

6/30/21

 Date

OFFICE USE ONLY		
Remarks: _____	_____	_____
Approval: Zoning Administrator _____	Issued by: _____	Date: _____



OUTLAW
BARBER COMPANY



119 Plantation North Blvd | Goose Creek, SC 29445



SITE PLAN NTS

Client:
OUTLAW BARBER COMPANY

Location:
119 Plantation North Blvd
Unit C
Goose Creek, SC 29445

CAROLINA SIGN Co. 779.SIGN
107 St. James Ave
Ste A2
Goose Creek, SC 29445
843-779-7446
carolinasingnco.com

Project Updates

- ▲ June 29th '21 HW
- ▲ n/a
- ▲ n/a
- ▲ n/a
- ▲ n/a
- ▲ n/a
- ▲ n/a
- ▲ n/a
- ▲ n/a

Project Manager:
Hugh Welch
E-Mail:
hugh@carolinasingnco.com

Approval Signatures

X
Client

X
Landlord

Customer is responsible for providing a dedicated electrical circuit within six feet of each sign location and any desired electrical timing devices.

This original unpublished drawing is submitted solely for the project being planned. It is not to be copied or shown to persons outside of your organization without express written authorization from CAROLINA SIGN COMPANY. All specified details on these drawings are subject to change due to the availability of materials and/or changes in the method of fabrication. CAROLINA SIGN COMPANY will do their best to maintain the design intent of these drawings at all times. If the owner or owner's representative wishes to receive detail drawings on all changes during the fabrication process, CAROLINA SIGN COMPANY must be advised in writing prior to the start of fabrication.

Sheet Title
Site

Page Number

1 of 4

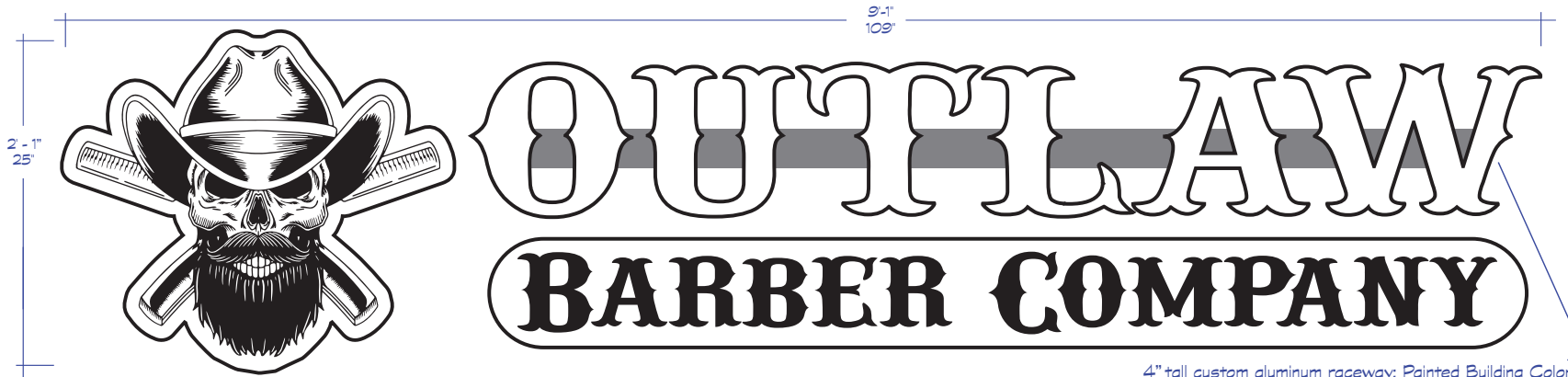

4" tall custom aluminum raceway; Painted Building Color

A	INTERNALLY-ILLUMINATED CHANNEL DISPLAY ON RACEWAY	Sign Area 15.125 sf
----------	--	--------------------------------

Fabricate & install one (1) set of internally-illuminated, aluminum, pan channel letters: "OUTLAW " letters to have 5.5" deep returns (black); white acrylic faces w/ 1" white trim cap.

"LOGO" to have 6" deep return; white acrylic faces, paint/vinyl.

"BARBER COMPANY" to have 6" deep return; white acrylic face, black vinyl.

Characters to be mounted to an aluminum raceway (painted to match building). Illuminate using white LEDs to raceway-mounted power supplies (see detail).

PC Letter / LEDs - Cross Section Detail

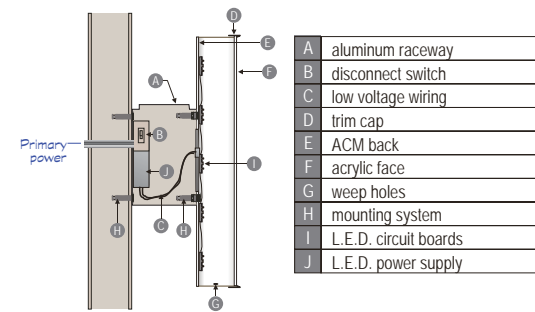

THIS SIGN IS INTENDED TO BE INSTALLED IN ACCORDANCE WITH THE REQUIREMENTS OF ARTICLE 600 OF THE NATIONAL ELECTRICAL CODE AND/OR OTHER APPLICABLE LOCAL CODES. THIS INCLUDES PROPER GROUNDING AND BONDING OF THE SIGN. **U.L. LISTED**

Client:
OUTLAW BARBER COMPANY

Location:
119 Plantation North Blvd
Unit C
Goose Creek, SC 29445

CAROLINA SIGN Co 779.SIGN

107 St. James Ave
Ste A2
Goose Creek, SC 29445
843-779-7446
carolinasingnco.com

Project Updates

- ▲ June 29th '21 HW
- ▲ n/a
- ▲ n/a
- ▲ n/a
- ▲ n/a
- ▲ n/a
- ▲ n/a
- ▲ n/a
- ▲ n/a
- ▲ n/a

Project Manager:
Hugh Welch
E-Mail:
hugh@carolinasingnco.com

Approval Signatures

X Client

X Landlord

Customer is responsible for providing a dedicated electrical circuit within six feet of each sign location and any desired electrical timing devices.

This original unpublished drawing is submitted solely for the project being planned. It is not to be copied or shown to persons outside of your organization without express written authorization from CAROLINA SIGN COMPANY. All specified details on these drawings are subject to change due to the availability of materials and/or changes in the method of fabrication. CAROLINA SIGN COMPANY will do their best to maintain the design intent of these drawings at all times. If the owner or owners' representative wishes to receive detail drawings on all changes during the fabrication process, CAROLINA SIGN COMPANY must be advised in writing prior to the start of fabrication.

Sheet Title
Exterior

Page Number

2 of 4

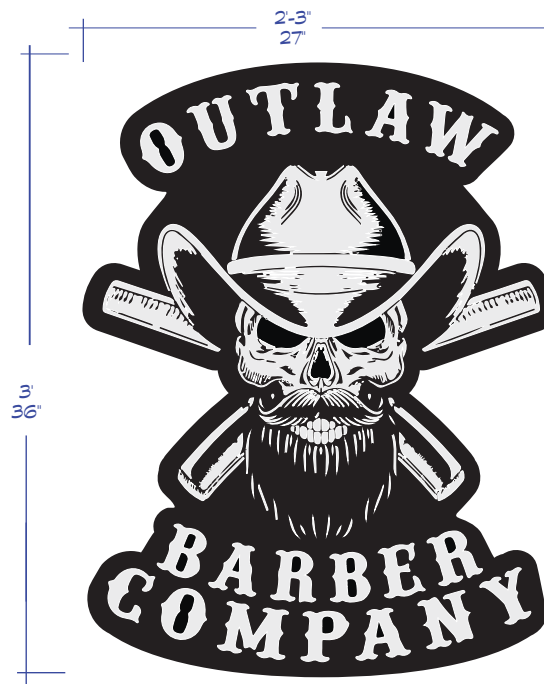

A INTERNALLY-ILLUMINATED CHANNEL DISPLAY Sign Area 6.75 sf

Fabricate & install one (1) set of internally-illuminated, aluminum, pan channel letters: "WIDE AWAKE BREWING COMPANY" letters to have 5.5" deep returns (black); white acrylic faces w/ 1" white trim cap.

"LOGO" to have 6" deep return; white acrylic faces, paint/vinyl.

Characters to be mounted to an aluminum raceway (painted to match building). Illuminate using white LEDs to raceway-mounted power supplies (see detail).

PC Letter / LEDs - Cross Section Detail

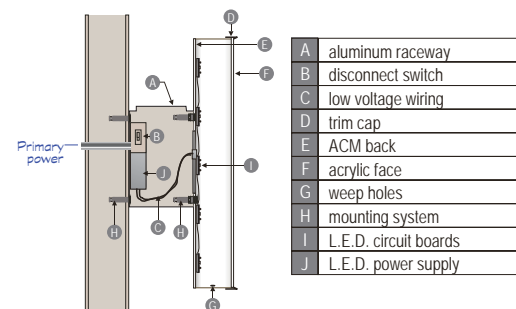

THIS SIGN IS INTENDED TO BE INSTALLED IN ACCORDANCE WITH THE REQUIREMENTS OF ARTICLE 600 OF THE NATIONAL ELECTRICAL CODE AND/OR OTHER APPLICABLE LOCAL CODES. THIS INCLUDES PROPER GROUNDING AND BONDING OF THE SIGN. **U.L. LISTED**

Client:
OUTLAW BARBER COMPANY

Location:
119 Plantation North Blvd
Unit C
Goose Creek, SC 29445

CAROLINA SIGN co 779.SIGN

107 St. James Ave
Ste A2
Goose Creek, SC 29445
843-779-7446
carolinastgnco.com

Project Updates

- ▲ June 29th '21 HW
- ▲ n/a
- ▲ n/a
- ▲ n/a
- ▲ n/a
- ▲ n/a
- ▲ n/a
- ▲ n/a
- ▲ n/a

Project Manager:
Hugh Welch
E-Mail:
hugh@carolinastgnco.com

Approval Signatures

X Client
X Landlord

Customer is responsible for providing a dedicated electrical circuit within six feet of each sign location and any desired electrical timing devices.

This original unpublished drawing is submitted solely for the project being planned. It is not to be copied or shown to persons outside of your organization without express written authorization from CAROLINA SIGN COMPANY. All specified details on these drawings are subject to change due to the availability of materials and/or changes in the method of fabrication. CAROLINA SIGN COMPANY will do their best to maintain the design intent of these drawings at all times. If the owner or owner's representative wishes to receive detail drawings on all changes during the fabrication process, CAROLINA SIGN COMPANY must be advised in writing prior to the start of fabrication.

Sheet Title
Exterior

Page Number

3 of 4



CURRENT & PROPOSED

Client:
OUTLAW BARBER COMPANY

Location:
 119 Plantation North Blvd
 Unit C
 Goose Creek, SC 29445

CAROLINA SIGN Co 779.SIGN

107 St. James Ave
 Ste A2
 Goose Creek, SC 29445
 843-779-7446
 carolinasignco.com

Project Updates

- ▲ June 29th '21 HW
- ▲ n/a
- ▲ n/a
- ▲ n/a
- ▲ n/a
- ▲ n/a
- ▲ n/a
- ▲ n/a
- ▲ n/a

Project Manager:
 Hugh Welch
 E-Mail:
 hugh@carolinasignco.com

Approval Signatures

Client

Landlord

Customer is responsible for providing a dedicated electrical circuit within six feet of each sign location and any desired electrical timing devices.

This original unpublished drawing is submitted solely for the project being planned. It is not to be copied or shown to persons outside of your organization without express written authorization from CAROLINA SIGN COMPANY. All specified details on these drawings are subject to change due to the availability of materials and/or changes in the method of fabrication. CAROLINA SIGN COMPANY will do their best to maintain the design intent of these drawings at all times. If the owner or owner's representative wishes to receive detail drawings on all changes during the fabrication process, CAROLINA SIGN COMPANY must be advised in writing prior to the start of fabrication.

Sheet Title
 Exterior

Page Number

4 of 4



NEW BUSINESS: MINOR APPLICATIONS

2021-048 SIG

GOD'S LITTLE MASTERMINDS/DELIVERANCE & FAITH MINISTRIES

SIGNAGE



CITY OF GOOSE CREEK
SIGN PERMIT APPLICATION

PAID

PERMIT #: <u>044119</u>	OFFICE USE ONLY
AMOUNT DUE: \$ <u>75.00</u>	DATE PAID: <u>7/6/21</u>
LICENSE#: _____	DATE PAID: <u> / /</u>

Permit Fee: \$75.00

Today's Date: 6/30/21

1. Business Owner Victoria Pearson Business Phone [REDACTED]

Name of Business Deliverance + Faith Ministries DBA Alternate Phone _____
God's Little Masterminds

Street Address of Business 107 St. James Ave Ste. B-1/B-2

Landlord/Lessor Elam's Investments Landlord's Phone _____

Sign Company Carolina Moon Signs Sign Co. Phone [REDACTED]

Sign Co. Contact Hugh Welch Sign Co. Address [REDACTED]

2. Cost of Sign(s) \$ [REDACTED] Sign Installation Cost \$ [REDACTED] Total Cost \$ [REDACTED]

3. How many signs are you applying for? 1 How many signs does this business already have? 0

4. What kind of signs does this business already have? existing cabinet None

5. What type of business is applying for this sign permit:

A. A stand alone business? Yes No

B. A part of a shopping center? Yes No If yes, shopping center name: Elam's Crossroads

6. What is the TMS number for this property? 243-12-07-015

7. What is the front setback of the business in feet? 155' (The distance from the front property line to the front of business)

A. For corner lots only, what is the front setback for second street frontage in feet? _____

8. What is the width of the business in feet? 25' (The distance from wall to wall)

A. For corner lots only, what is the width of the business for second street frontage in feet? _____

9. What is the property's road frontage in feet? _____ (This only applies to shopping centers erecting a freestanding sign)

10. Please attach photos showing:
- A. The storefront in relation to adjacent businesses;
 - B. The specific location of proposed sign(s) on the property or building; and
 - C. The actual sign if it already exists.

11. Please attach drawings of each proposed sign showing (drawn to scale):
- A. The completed sign as it will actually appear on the building
 - B. All dimensions;
 - C. Where the colors will appear;
 - D. The location on the property (on a plat) of proposed & existing freestanding signs
 - E. The location on the building of proposed & existing building signs

12. Please attach swatches, samples, and/or paint chips of all proposed colors to the application

13. Please complete the Sign Information Table located on the following page.

14. You are required to attend the Architectural Review Board meeting in which your sign application is reviewed.

- Please submit this application by the 1st Monday of the month for consideration that month by the ARB.
- The ARB meets on the 3rd Monday of each month. (Please see attached ARB schedule for application deadlines and meetings.)

OFFICE USE ONLY
MAX. NO. OF ALLOWED SIGNS: <u>2</u>
MAX ALLOWED SIGN AREA: <u>25SF</u>

sign permit application meets ordinance criteria as outlined in section 151.084 of the City Zoning Ordinance. Please add to July 19th ARB meeting Agenda.

[Signature]

NOTE: Illuminated, exposed and non-exposed neon signs located on the interior of a business, which are visible from the exterior of the business, must be reviewed by the ARB. Such signs shall be included as part of a business's maximum allowable square footage of building signage, as authorized in Section 151.084 of the City Code. A "non-exposed neon sign" shall be interpreted as a neon sign that does not have externally visible neon tubing. Neon signs enclosed in plastic, glass and Plexiglas casings are considered "exposed neon signs." All electrical work must be in accordance with the City's Code of Ordinances and the National Electrical Code.

Note: This application contains multiple pages

SIGN INFORMATION TABLE

Required Information	Sign 1	Sign 2	Sign 3
Materials: (metal, plastic, wood, etc.)	Acrylic Panel		
Illumination: Exterior, interior or not lighted	Interior		
Type of Sign:	Wall Mount (Existing)		
Height (FEET)	2.5'		
Width (feet)	10'		
Area (square feet)	25 s/p		
All colors used on sign	Black/White / Blue / Orange / Yellow		
Is there a graphic (picture) on the sign? (Y/N) If yes, size of graphic	Yes 15" circle logo		
Projection from building or cabinet width (thickness)	6"		
Number of styles of lettering	ONE		
Height of letters (if channel letters)	N/A		
If mounting individual letters, space between letters	N/A		
If mounting individual letters, space between words	N/A		
If window sign, size of window	N/A		
If changeable copy sign (reader board), number of lines	N/A		
If freestanding sign, distance between sign and street curb (ft)	N/A		
If freestanding sign, total height above grade (ft)	N/A		
If freestanding sign, landscaping materials to be planted at base of sign	N/A		

Review the attached Zoning Ordinances pertaining to sign regulations (Section 151.084). Be advised to examine them thoroughly so as to avoid violations (Section 151.999):

By signing below, you certify the above information that you provided to be true and correct.

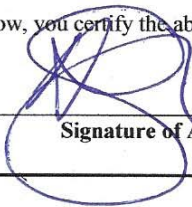

Signature of Applicant

6/30/21

Date

OFFICE USE ONLY

Remarks: _____

Approval: Zoning Administrator _____ Issued by: _____ Date: _____

A



God's Little Master Minds

Deliverence & Faith Ministries

107 St James Ave Ste B-1 | Goose Creek, SC 29445



SITE PLAN NTS

Client:
Deliverence and Faith Ministries DBA God's Little Masterminds

Location:
107 St James Ave
Ste B-1 / B-2
Goose Creek, SC 29445

CAROLINA SIGN Co. 779.SIGN

107 St. James Ave
Ste A2
Goose Creek, SC 29445
843-779-7446
carolinasignco.com

Project Updates

- ▲ June 29th '21 HW
- ▲ n/a
- ▲ n/a
- ▲ n/a
- ▲ n/a
- ▲ n/a
- ▲ n/a
- ▲ n/a
- ▲ n/a
- ▲ n/a

Project Manager:
Hugh Welch
E-Mail:
hugh@carolinasignco.com

Approval Signatures

X Client

X Landlord

Customer is responsible for providing a dedicated electrical circuit within six feet of each sign location and any desired electrical timing devices.

This original unpublished drawing is submitted solely for the project being planned. It is not to be copied or shown to persons outside of your organization without express written authorization from CAROLINA SIGN COMPANY. All specified details on these drawings are subject to change due to the availability of materials and/or changes in the method of fabrication. CAROLINA SIGN COMPANY will do their best to maintain the design intent of these drawings at all times. If the owner or owner's representative wishes to receive detail drawings on all changes during the fabrication process, CAROLINA SIGN COMPANY must be advised in writing prior to the start of fabrication.

Sheet Title
Site

Page Number
1 of 3



A	INTERNALLY-ILLUMINATED CABINET DISPLAY		Sign Area 25 sf
---	--	--	--------------------

Fabricate & install one (1) set of Vinyl Lettering on existing acrylic panel and internally-illuminated cabinet.

Primary power

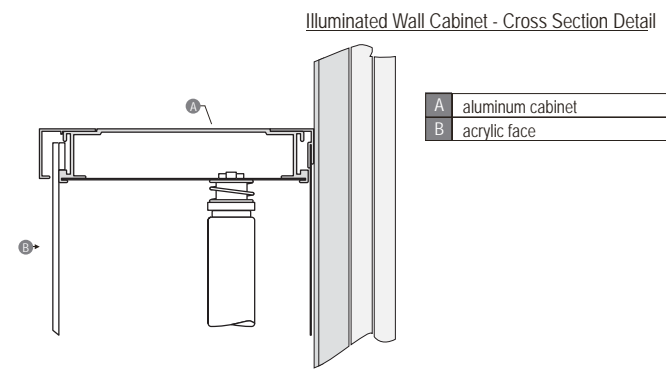

THIS SIGN IS INTENDED TO BE INSTALLED IN ACCORDANCE WITH THE REQUIREMENTS OF ARTICLE 600 OF THE NATIONAL ELECTRICAL CODE AND/OR OTHER APPLICABLE LOCAL CODES. THIS INCLUDES PROPER GROUNDING AND BONDING OF THE SIGN. **U.L. LISTED**

Client:
Deliverance and Faith Ministries DBA God's Little Masterminds

Location:
107 St James Ave
Ste B-1 / B-2
Goose Creek, SC 29445

CAROLINA SIGN Co 779.SIGN

107 St. James Ave
Ste A2
Goose Creek, SC 29445
843-779-7446
carolinasignco.com

Project Updates

- ▲ June 29th '21 HW
- ▲ n/a
- ▲ n/a
- ▲ n/a
- ▲ n/a
- ▲ n/a
- ▲ n/a
- ▲ n/a
- ▲ n/a
- ▲ n/a

Project Manager:
Hugh Welch
E-Mail:
hugh@carolinasignco.com

Approval Signatures

X Client

X Landlord

Customer is responsible for providing a dedicated electrical circuit within six feet of each sign location and any desired electrical timing devices.

This original unpublished drawing is submitted solely for the project being planned. It is not to be copied or shown to persons outside of your organization without express written authorization from CAROLINA SIGN COMPANY. All specified details on these drawings are subject to change due to the availability of materials and/or changes in the method of fabrication. CAROLINA SIGN COMPANY will do their best to maintain the design intent of these drawings at all times. If the owner or owners representative wishes to receive detail drawings on all changes during the fabrication process, CAROLINA SIGN COMPANY must be advised in writing prior to the start of fabrication.

Sheet Title
Exterior

Page Number

2 of 3



CURRENT & PROPOSED

Client:
 Deliverance and Faith Ministries DBA God's Little Masterminds
 Location:
 107 St James Ave
 Ste B-1 / B-2
 Goose Creek, SC 29445

CAROLINA SIGN CO 779.SIGN
 107 St. James Ave
 Ste A2
 Goose Creek, SC 29445
 843-779-7446
 carolinasignco.com

Project Updates

▲	June 29th '21 HW
▲	n/a
▲	n/a
▲	n/a
▲	n/a
▲	n/a
▲	n/a
▲	n/a
▲	n/a

Project Manager:
 Hugh Welch
 E-Mail:
 hugh@carolinasignco.com

Approval Signatures
 X Client
 X Landlord

Customer is responsible for providing a dedicated electrical circuit within six feet of each sign location and any desired electrical timing devices.

This original unpublished drawing is submitted solely for the project being planned. It is not to be copied or shown to persons outside of your organization without express written authorization from CAROLINA SIGN COMPANY. All specified details on these drawings are subject to change due to the availability of materials and/or changes in the method of fabrication. CAROLINA SIGN COMPANY will do their best to maintain the design intent of these drawings at all times. If the owner or owner's representative wishes to receive detail drawings on all changes during the fabrication process, CAROLINA SIGN COMPANY must be advised in writing prior to the start of fabrication.

Sheet Title
 Exterior

Page Number
 3 of 3



NEW BUSINESS: MINOR APPLICATIONS

2021-049 ROOF

RIPLEY'S ACCOUNTING

RE-ROOF



ARB SCOPE OF WORK FORM/

APPLICATION / INFORMATION SUMMARY

DEPARTMENT OF PLANNING AND ZONING 843-797-6220 EXT. 1118

P.O. Drawer 1768

519 N. Goose Creek Blvd.

Goose Creek, South Carolina 29445-1768

www.cityofgoosecreek.com

Fax: 843-863-5208

Property Address: 205 Redbank Rd Goose Creek, SC 29445		TMS No.: 2441303012
Review request: <input checked="" type="checkbox"/> Preliminary <input checked="" type="checkbox"/> Final	For: <input type="checkbox"/> New Construction <input checked="" type="checkbox"/> Alterations / Additions <input type="checkbox"/> Color Change <input type="checkbox"/> Demolition <input type="checkbox"/> Other _____	Preliminary meeting date requested: 7/19/2021 <input type="checkbox"/> Appeal Decision of Architectural Review Board

Property Owner: Claudia Thomas & Vivian Ripley	Daytime phone: [REDACTED]
Applicant: Williford Roofing and Construction	Daytime phone: [REDACTED]
ARB Meeting Representative:	Contact Information : Mindy Parish
Applicant's mailing address: [REDACTED]	
City: North Charleston	State: [REDACTED] Zip: [REDACTED]
Applicant's e-mail address: [REDACTED]	
Applicant's relationship: <input type="checkbox"/> Owner <input type="checkbox"/> Design Professional <input checked="" type="checkbox"/> Contractor <input type="checkbox"/> Real Estate Agent/Broker <input type="checkbox"/> Other	

Materials/Colors Used: (specific color(s)/manufacture #'s listed: samples must be presented to Board <input checked="" type="checkbox"/> attached) (Example: Building Materials, Exterior Colors, Landscaping, Lighting)
White metal fascia White vinyl siding 30yr Architectural shingle color: Weatherwood
Scope of Work: (please give a detailed description)
Install trusses on 24" center to plan specs Install 5/8 OSB on entire roof surface Install 7/16 OSB on gable ends for sheathing Install 2x6 sub-fascia on all fascia Install synthetic underlayment on entire roof surface Extend all plumbing and gas vents through roof Install 30 year architectural shingles on entire roof surface with drip edge Install white metal on all fascia, white vinyl soffit on all soffits Install white vinyl siding on gable ends

I hereby acknowledge by my signature below that the foregoing application is complete and accurate and that I am the owner of the subject property or an authorized representative. I authorize the subject property to be posted and inspected, and the application to be heard by the Architectural Review Board of the City of Goose Creek on the date specified.

Applicant's signature: Mindy Parish Date: 6/21/2021
Print name legibly: Mindy Parish

NOTES

WIND DESIGN LOADS ($V = 147$ MPH, EXPOSURE CATEGORY 'B' or 'C')
STRUCTURE
 DESIGN IN ACCORDANCE WITH 2018 INTERNATIONAL BUILDING CODE FOR SEISMIC D
 AND 147 MILE PER HOUR (MPH) 3-SECOND GUST OR 116 MPH SUSTAINED WIND.

TIMBER
 ALL WOOD FRAMING MEMBERS SHALL BE SOUTHERN YELLOW PINE, GRADE 2.

BUTT SEAMS IN ORDERS, BEAMS AND HEADERS, INCLUDING INDIVIDUAL MEMBERS IN
 MULTIPLY BEAMS, SHALL BE LOCATED AT SUPPORTS.

LUMBER AND ENGINEERED WOOD PRODUCTS EXPOSED TO WEATHER OR EXPOSED TO
 MASONRY OR CONCRETE SHALL BE PRESSURE TREATED IN ACCORDANCE WITH THE
 AMERICAN WOOD PRESERVERS ASSOCIATION (AWPA) GUIDELINES FOR THE SPECIFIED EXPOSURE.
 CUT ENDS OF PRESSURE TREATED MEMBERS SHALL BE COATED WITH THE MANUFACTURER'S/
 SUPPLIERS APPROVED PRESERVATIVE. LUMBER SHALL BE TREATED FOR ABOVE OR BELOW
 GROUND USE AS APPLICABLE.

EXTERIOR WALL SHEATHING SHALL BE 7/16" CDX SHEATHING GRADE PLYWOOD OR OSB NAILED WITH 8d NAILS
 SPACED 3" ON CENTER ON PANEL EDGES AND 6" ON CENTER ON INTERMEDIATE FRAMES. PROVIDE
 SOLID BLOCKING AND NAIL ALL HORIZONTAL SEAMS 3" ON CENTER. EXTERIOR SHEATHING SEAMS
 SHALL NOT BE LOCATED WITHIN 12" ABOVE OR BELOW A TOP OR BOTTOM PLATE. SHEATHING SHALL
 BE NAILED TO BOTTOM OF THE EXTERIOR BAND AND TO THE TOP OF THE DOUBLE TOP PLATE. ALL
 OPENINGS SHALL BE NAILED WITH 8d NAILS SPACED 2" ON CENTER.

ALL STRAPS/CONNECTORS SPECIFIED ARE SIMPSON STRONG TIE. SEE MANUFACTURER'S MANUALS
 FOR INSTALLATION INSTRUCTIONS AND DETAILS. CONNECTORS NAILED TO SINGLE FRAMING MEMBERS
 SHALL USE EQUIVALENT DIAMETER SHORT NAILS SUCH AS SIMPSON N8 OR N10. ALL STRAPS AND
 CONNECTORS SHALL BE GALVANIZED.

NAILS, BOLTS AND FASTENERS IN CONTACT WITH TREATED LUMBER OR EXPOSED TO WEATHER,
 MASONRY OR CONCRETE SHALL BE GALVANIZED OR STAINLESS STEEL TO PROTECT FROM CORROSION.

NAIL SIZES SHOWN ARE BASED ON COMMON OR HOT DIPPED GALVANIZED BOX NAILS. IF OTHER
 TYPES OF NAILS ARE USED, INCREASE THE SIZE OF THE EQUIVALENT DIAMETER.

MANUFACTURER'S OF TJS, LAM BEAMS, TRUSSES AND OTHER ENGINEERED WOOD PRODUCTS SHALL
 VERIFY THE DESIGN OF THEIR PRODUCTS AND PROVIDE ANY AND ALL REQUIREMENTS FOR PROPER
 INSTALLATION (I.E., BLOCKING, PURLINS, WEB STIFFENING, NAILING/BOLTING PATTERNS, ETC.).

MANUFACTURER'S OF ROOF TRUSS SYSTEMS SHALL PROVIDE UPLIFT DESIGN CRITERIA FOR REVIEW
 BY THE ENGINEER.

DESIGN IS AND CONSTRUCTION SHALL BE IN ACCORDANCE WITH ASCE 7-16, MINIMUM DESIGN LOADS AND ASSOCIATED
 CRITERIA FOR BUILDINGS AND OTHER STRUCTURES AND THE 2018 IRC AND 2018 IBC.

ALL EXTERIOR SYSTEMS/FURNISHINGS (ROOFING, DOORS, WINDOWS, SHUTTERS, ETC.) SHALL
 BE RATED FOR 147 MPH WIND LOADS IN ACCORDANCE WITH THE 2018 INTERNATIONAL RESIDENTIAL CODE FOR
 ONE- AND TWO-FAMILY DWELLINGS AND THE 2018 INTERNATIONAL BUILDING CODE.

ALL INSTALLATIONS SHALL CONFORM TO GOOD CONSTRUCTION PRACTICE.

CONCRETE

CONCRETE SHALL BE A MINIMUM OF 3,000 psi.

ALL CONCRETE WORK SHALL COMPLY WITH AMERICAN CONCRETE INSTITUTE BUILDING CODE
 REQUIREMENTS FOR STRUCTURAL CONCRETE (ACI318).

SLUMP SHALL NOT EXCEED 4".

CONCRETE SHALL BE CAST IN PLACE AND COMPACTED BY VIBRATING AND SUPPLEMENTED WITH HAND
 TAMPING AND SPADING AS REQUIRED.

CURING OF CONCRETE SHALL BE MADE WITH LIQUID MEMBRANE CURING COMPOUND IN ACCORDANCE
 WITH THE MANUFACTURER'S INSTRUCTIONS. CONCRETE SHALL BE MAINTAINED ABOVE 50° F AND IN A
 MOIST CONDITION FOR AT LEAST THE FIRST 7 DAYS AFTER PLACEMENT UNLESS OTHERWISE NOTED.

REINFORCING STEEL

ALL REBAR SHALL BE GRADE 60 OR 60S, DEFORMED CONFORMING WITH ASTM 615.

ALL LAP DISTANCES SHALL BE 40 BAR DIAMETERS UNLESS OTHERWISE NOTED.

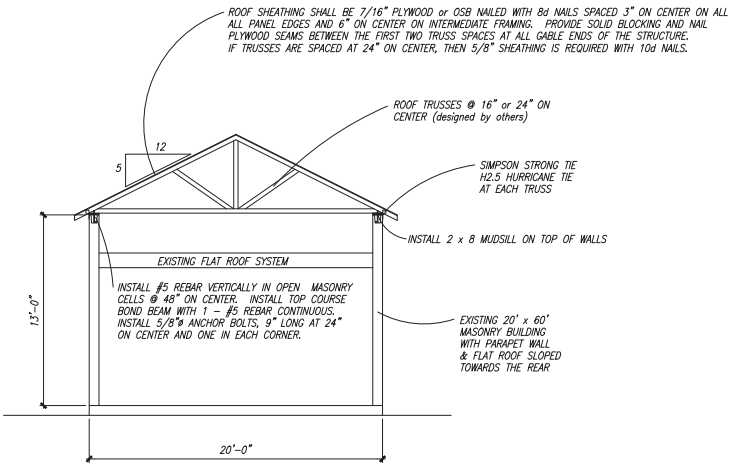

STRUCTURAL SECTION

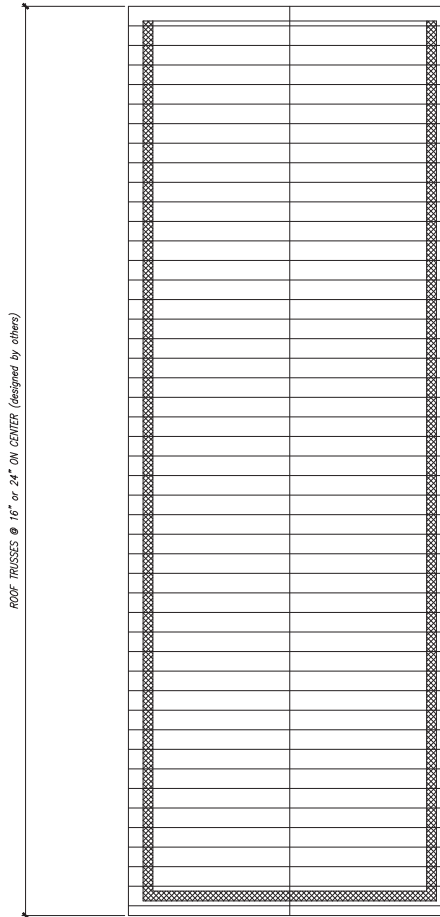

ROOF FRAMING PLAN

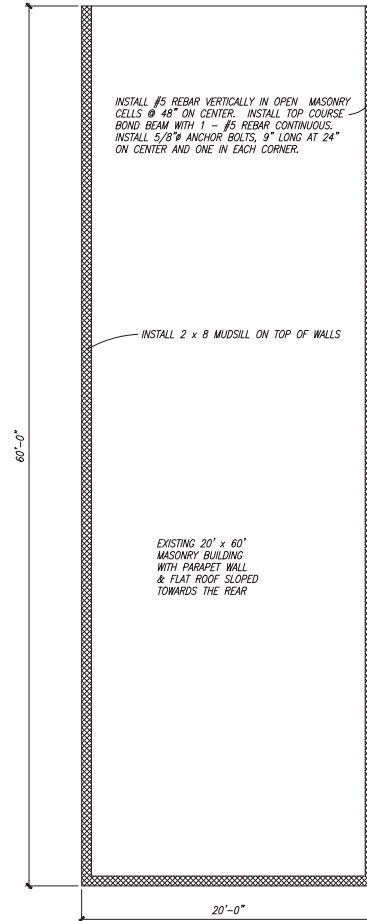

PLAN VIEW

SCALE: 1/4" = 1'-0"

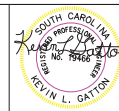

05/07/2021

DATE 05/07/2021

DRAWN klg

JOB RIPLEY'S

SHEET:

S1

GW & ASSOCIATES, LLC
 KEVIN L. GATTION, P. E.
 PO BOX 726
 ISLE OF PALMS, SC 29451
 (843) 270-0588
 (843) 849-1922 fax

INSTALLATION OF NEW PITCHED ROOF OVER EXISTING FLAT ROOF
RIPLEY'S ACCOUNTING & TAX SERVICE
 205 ST. JAMES BOULEVARD, GOOSE CREEK, SOUTH CAROLINA 29445



REAR

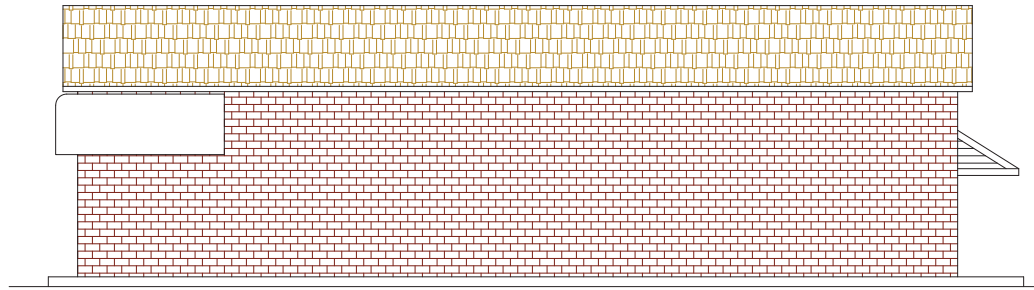

RIGHT

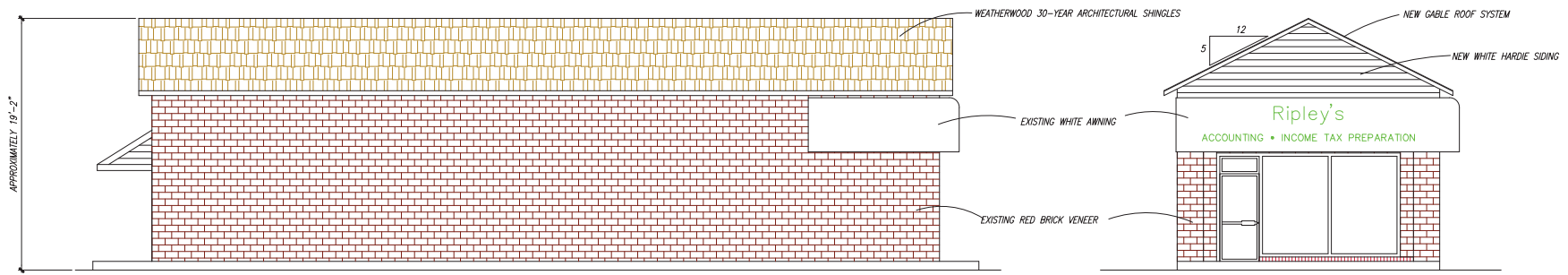

LEFT

FRONT

SCALE: 1/4" = 1'-0"

Design by
Ripley's & Deven Smith
Construction by
Willford Roofing & Const.

RIPLEY'S ACCOUNTING & TAX SERVICE

205 ST. JAMES BOULEVARD, GOOSE CREEK, SOUTH CAROLINA 29445

PROPOSED NEW ELEVATIONS

DATE	07/05/2021
DRAWN	klg
JOB	RIPLEY'S R1
SHEET	A1

